

ARAFLEX

Mangueiras e Conexões Hidráulicas



CATÁLOGO DE
PRODUTOS

Terminais | Adaptadores | Conexões | Mangueiras



Fundada em 2001, a Araflex evoluiu. Conta hoje com os equipamentos mais modernos para montagem de mangueiras hidráulicas.

Nossos Atributos

Visão

Torna-se uma empresa reconhecida como referencia no mercado e nos negócios em que atua.

Missão

No estado do Espírito Santo e no Brasil temos o compromisso de atender o mercado com soluções e produtos de altíssima qualidade levando a todos os clientes tecnologia, desenvolvimento de serviços que agregam valor, com segurança buscando sempre uma relação de parceria com nossos clientes e fornecedores.

Valores

Ter preferência do cliente;
Segurança das pessoas acima de tudo;
Pessoas respeitadas, comprometidas e realizadas;
Excelência com simplicidade;
Integridade com todos os públicos;
Sustentabilidade econômica, social e ambiental e
Foco em resultados com legitimidade.

TERMINAIS STANDARD

PAG. 9

<i>CODIGO</i>	<i>PRODUTO</i>	<i>PAG.</i>
CTM	CAPA PRENSADA PARA MANGUEIRA R7/R8 (NO SKIVE)	10
CPTF	CAPA PRENSADA PARA MANGUEIRA TEFLON®/SAE100R14 (NO SKIVE)	10
CPT2210	CAPA PRENSADA PARA MANGUEIRA SAE100 R2AT (NO SKIVE)	10
CSD	CAPA PRENSADA PARA MANGUEIRA SAE100 R1AT/R2AT (NO SKIVE)	11
CCD	CAPA PRENSADA PARA MANGUEIRA R12 / 4SP / 4SH (SKIVE)	11
CPR	CAPA PRENSADA RAIADA PARA MANGUEIRA R12 / 4SH (SKIVE)	11
TMJ	MACHO FIXO UNF JIC 37° SAE J514	12
TFGJ	FÊMEA GIRATÓRIA RETA UNF JIC 37° SAE J514	13
TFGJ45	FÊMEA GIRATÓRIA CURVA 45° UNF JIC 37° SAE J514	14
TFGJ90	FÊMEA GIRATÓRIA CURVA 90° UNF JIC 37° SAE J514	15
TFGJ90L	FÊMEA GIRATÓRIA CURVA 90° LONGA UNF JIC 37° SAE J514	16
TFGJS	FÊMEA GIRATÓRIA RETA UNF JIC 45° SAE J514	16
TFGJS90	FÊMEA GIRATÓRIA CURVA 90° UNF JIC 45° SAE J514	16
TMFKT	MACHO FIXO MÉTRICO KOMATSU SEDE 60°/JIS B8363	17
TFGKT	FÊMEA GIRATÓRIA MÉTRICA KOMATSU SEDE 60°/ JIS B8363	17
TFGKT90	FÊMEA GIRATÓRIA CURVA 90° MÉTRICA KOMATSU SEDE 60°/JIS B8363	17
TMFM	MACHO MÉTRICO PARA TUBO - SÉRIE LEVE SEDE 24°/DIN 3853 - 3861	18
TMFM	MACHO MÉTRICO PARA TUBO - SÉRIE PESADA SEDE 24°/DIN 3853 - 3861	19
TDKO	FÊMEA GIRATÓRIA MÉTRICA RETA DKO - SÉRIE LEVE SEDE 24°/DIN 3865	20
TDKO	FÊMEA GIRATÓRIA MÉTRICA RETA DKO - SÉRIE PESADA SEDE 24°/DIN 3865	21
TDKO45	FÊMEA GIRATÓRIA MÉTRICA CURVA 45° DKO - SÉRIE LEVE SEDE 24°/DIN 3865	22
TDKO45	FÊMEA GIRATÓRIA MÉTRICA CURVA 45° DKO - SÉRIE PESADA SEDE 24°/DIN 3865	22
TDKO90	FÊMEA GIRATÓRIA MÉTRICA CURVA 90° DKO - SÉRIE LEVE SEDE 24°/DIN 3865	23
TDKO90	FÊMEA GIRATÓRIA MÉTRICA CURVA 90° DKO - SÉRIE PESADA SEDE 24°/DIN 3865	24
TMFPC	MACHO RETO MÉTRICO POCLAIN SEDE 24°/ROSCA MÉTRICA FINA	25
TFGPC	FÊMEA MÉTRICA POCLAIN SEDE 24°/ROSCA MÉTRICA FINA	25
TMFP	MACHO FIXO NPT SEDE 60°/SAE J516	26
TFFP	FÊMEA FIXA NPT	26
TMFO	MACHO FIXO O'RING - UNF SAE J512	27
TMFSP	MACHO FIXO SEDE PLANA - ORFS SAE J1453	27
TFGSP	FÊMEA GIRATÓRIA RETA SEDE PLANA ORFS SAE J1453	28
TFGSP45	FÊMEA GIRATÓRIA CURVA 45° SEDE PLANA ORFS SAE J1453	28
TFGSP90	FÊMEA GIRATÓRIA CURVA 90° SEDE PLANA ORFS SAE J1453	29
TFGSP90L	FÊMEA GIRATÓRIA CURVA 90° LONGA SEDE PLANA ORFS SAE J1453	29
TFGSPM	FÊMEA GIRATÓRIA RETA SEDE PLANA ORFS MÉTRICA	30
TFGSPM45	FÊMEA GIRATÓRIA CURVA 45° SEDE PLANA ORFS MÉTRICA	30
TFGSPM90	FÊMEA GIRATÓRIA CURVA 90° SEDE PLANA ORFS MÉTRICA	31
TFGSPB	FÊMEA GIRATÓRIA RETA ROSCA BSP SEDE 60°/JIS B8363	31
TFGSPB90	FÊMEA GIRATÓRIA CURVA 90° ROSCA BSP SEDE 60°/JIS B8369	32
TMFB	MACHO FIXO BSP SEDE 60°/BS 5200	32
TSFB	FÊMEA GIRATÓRIA BSP SEDE 60°/BS 5200	33
TSFB45	FÊMEA GIRATÓRIA CURVA 45° BSP SEDE 60°/BS 5200	34
TSFB90	FÊMEA GIRATÓRIA CURVA 90° BSP SEDE 60°/BS 5200	35
TFGB	FÊMEA GIRATÓRIA RETA MÉTRICA BOLEADA - SEDE UNIVERSAL	35
TFGB45	FÊMEA GIRATÓRIA CURVA 45° MÉTRICA BOLEADA - SEDE UNIVERSAL	36
TFGB90	FÊMEA GIRATÓRIA CURVA 90° MÉTRICA BOLEADA - SEDE UNIVERSAL	36
TFGJB	FÊMEA GIRATÓRIA RETA BSP/JIC CÔNICO 30°	36

TERMINAIS STANDARD

PAG. 9

<i>CODIGO</i>	<i>PRODUTO</i>	<i>PAG.</i>
TFGCB90	FÊMEA GIRATÓRIA COMPACTA BSP CÔNICO 60°	37
TFR3	FLANGE RETA CÓD. 61 3000 PSI SAE J518	37
TFR345	FLANGE CURVA 45° CÓD. 61 3000 PSI SAE J518	38
TFR390	FLANGE CURVA 90° CÓD. 61 3000 PSI SAE J518	38
TFR390L	FLANGE CURVA 90° LONGA CÓD. 61 3000 PSI SAE J518	39
TFR6	FLANGE RETA CÓD. 62 6000 PSI SAE J518	39
TFR645	FLANGE CURVA 45° CÓD. 62 6000 PSI SAE J518	40
TFR690	FLANGE CURVA 90° CÓD. 62 6000 PSI SAE J518	40
TFR690L	FLANGE CURVA 90° LONGA CÓD. 62 6000 PSI SAE J518	41
TFR9	FLANGE RETA CAT (9000 PSI)	41
TFR945	FLANGE CURVA 45° CAT (9000 PSI)	41
TFR990	FLANGE CURVA 90° CAT (9000 PSI)	42
TPL	PONTA LISA RETA	43
TPL90	PONTA LISA CURVA 90°	44
EMH	EMENDA HIDRÁULICA	44
TOLM	OLHAL RETO - MÉTRICO	45
TOLB	OLHAL RETO - BSP	45
TSV	PINO SALVA VIDAS	46
TWASH	FÊMEA GIRATÓRIA KARCHER	46
TPMK	PINO MINI KARCHER	46

TERMINAIS INTERLOCK

PAG. 47

<i>CODIGO</i>	<i>PRODUTO</i>	<i>PAG.</i>
CIT	CAPA PRENSADA INTERLOCK PARA MANGUEIRA 4SH/ R13 (SKIVE)	48
TIF3	FLANGE RETA CÓD. 61 3000 PSI - INTERLOCK SAE J518	48
TIF345	FLANGE CURVA 45° CÓD. 61 3000 PSI - INTERLOCK SAE J518	48
TIF390	FLANGE CURVA 90° CÓD. 61 3000 PSI - INTERLOCK SAE J518	49
TIF6	FLANGE RETA CÓD. 62 6000 PSI - INTERLOCK SAE J518	49
TIF645	FLANGE CURVA 45° CÓD. 62 6000 PSI - INTERLOCK SAE J518	50
TIF690	FLANGE CURVA 90° CÓD. 62 6000 PSI - INTERLOCK SAE J518	50
TIF9	FLANGE RETA SUPERCAT 9000 PSI - INTERLOCK	51
TIF945	FLANGE CURVA 45° SUPERCAT 9000 PSI - INTERLOCK	51
TIF990	FLANGE CURVA 90° SUPERCAT 9000 PSI - INTERLOCK	52
TIF990L	FLANGE CURVA 90° LONGA SUPERCAT 9000 PSI - INTERLOC	52
TIFGJ	FÊMEA GIRATÓRIA RETA UNF JIC 37° - INTERLOCK SAE J514	52
TIFGJ45	FÊMEA GIRATÓRIA CURVA 45° UNF JIC 37° - INTERLOCK SAE J514	53
TIFGJ90	FÊMEA GIRATÓRIA CURVA 90° JIC 37° INTERLOCK	53
TIMFP	MACHO FIXO NPT - INTERLOCK SEDE 60°/ SAE J516	54
TIFGSP	FÊMEA GIRATÓRIA RETA SEDE PLANA (ORFS) - INTERLOCK SAE J1453	54
TIFGSP45	FÊMEA GIRATÓRIA CURVA 45° SEDE PLANA (ORFS) - INTERLOCK SAE J1453	54
TIFGSP90	FÊMEA GIRATÓRIA CURVA 90° SEDE PLANA (ORFS) - INTERLOCK SAE J1453	55
TIMFM	MACHO MÉTRICO PARA TUBO - INTERLOCK SEDE 24°/ DIN 38 53 - 38 61	55
TIDKO	FÊMEA GIRATÓRIA RETA MÉTRICA DKO - INTERLOCK SEDE 24°/ DIN 38 65	55

TERMINAIS INTERLOCK

PAG. 47

<i>CODIGO</i>	<i>PRODUTO</i>	<i>PAG.</i>
TIDKO45	FÊMEA GIRATÓRIA CURVA 45° MÉTRICA DKO - INTERLOCK SEDE 24°/ DIN 3865	56
TIDKO90	FÊMEA GIRATÓRIA CURVA 90° MÉTRICA DKO - INTERLOCK SEDE 24°/ DIN 3865	56
TIFGB	FÊMEA GIRATÓRIA RETA BSP - INTERLOCK SEDE 60°/ BS 5200	57
TIFGB45	FÊMEA GIRATÓRIA CURVA 45° BSP - INTERLOCK SEDE 60°/ BS 5200	57
TIFGB90	FÊMEA GIRATÓRIA CURVA 90° BSP - INTERLOCK SEDE 60°/ BS 5200	57

ADAPTADORES

PAG. 59

<i>CODIGO</i>	<i>PRODUTO</i>	<i>PAG.</i>
ADMJMJ	ADAPTADOR RETO MACHO JIC 37° X MACHO JIC 37°	60
AD90MJMJ	ADAPTADOR CURVA 90° MACHO JIC 37° X MACHO JIC 37°	61
ADMJMJL	ADAPTADOR RETO MACHO JIC 37° X MACHO JIC 37° PAINEL / LONGO	61
AD90MJMJL	ADAPTADOR CURVA 90° MACHO JIC 37° X MACHO JIC 37° PAINEL / LONGO	61
ADMJFJ	ADAPTADOR RETO MACHO JIC 37° X FÊMEA JIC 37°	62
AD45MJFJ	ADAPTADOR CURVA 45° MACHO JIC 37° X FÊMEA JIC 37°	62
AD90MJFJ	ADAPTADOR CURVA 90° MACHO JIC 37° X FÊMEA JIC 37°	63
ADMJMO	ADAPTADOR RETO MACHO UNF X MACHO JIC 37° COM O'RING	64
AD45MJMO	ADAPTADOR CURVA 45° MACHO UNF X MACHO JIC 37° COM PORCA ORIENTÁVEL	65
AD90MJMO	ADAPTADOR CURVA 90° MACHO UNF X MACHO JIC 37° COM PORCA ORIENTÁVEL	66
ADMJMM	ADAPTADOR RETO MACHO JIC 37° X MACHO MÉTRICO COM O'RING	67
AD45MJMM	ADAPTADOR CURVA 45° MACHO JIC 37° X MACHO MÉTRICO COM PORCA ORIENTÁVEL	68
AD90MJMM	ADAPTADOR CURVA 90° MACHO JIC 37° X MACHO MÉTRICO COM PORCA ORIENTÁVEL	69
ADMJMSP	ADAPTADOR RETO MACHO JIC 37° X MACHO ORFS SEDE PLANA	69
ADMJFFP	ADAPTADOR RETO MACHO JIC 37° X FÊMEA FIXA NPT	70
AD90MJFFP	ADAPTADOR CURVA 90° MACHO JIC 37° X FÊMEA FIXA NPT	70
ADMJMB	ADAPTADOR RETO MACHO JIC 37° X MACHO BSP COM O'RING	71
AD45MJMB	ADAPTADOR CURVA 45° MACHO JIC 37° X MACHO BSP COM PORCA ORIENTÁVEL	72
AD90MJMB	ADAPTADOR CURVA 90° MACHO JIC 37° X MACHO BSP COM PORCA ORIENTÁVEL	73
ADMJFL3	ADAPTADOR RETO MACHO JIC 37° X FLANGE CÓD 61	74
AD45MJFL3	ADAPTADOR CURVA 45° MACHO JIC 37° X FLANGE CÓD 61	74
AD90MJFL3	ADAPTADOR CURVA 90° MACHO JIC 37° X FLANGE CÓD 61	75
ADMJFL6	ADAPTADOR RETO MACHO JIC 37° X FLANGE CÓD 62	75
AD45MJFL6	ADAPTADOR CURVA 45° MACHO JIC 37° X FLANGE CÓD 62	76
AD90MJFL6	ADAPTADOR CURVA 90° MACHO JIC 37° X FLANGE CÓD 62	76
ADMJS	ADAPTADOR MACHO SOLDA JIC 37°	77
ADCMJ	ADAPTADOR CRUZETA MACHO JIC 37°	77
ADMPMP	ADAPTADOR RETO MACHO NPT X MACHO NPT	78
AD45MPMP	ADAPTADOR CURVA 45° MACHO NPT X MACHO NPT	78
AD90MPMP	ADAPTADOR CURVA 90° MACHO NPT X MACHO NPT	79
ADMPFF	ADAPTADOR RETO MACHO NPT X FÊMEA NPT	80
AD45MPFF	ADAPTADOR CURVA 45° MACHO NPT X FÊMEA NPT	81
AD90MPFF	ADAPTADOR CURVA 90° MACHO NPT X FÊMEA NPT	81
ADFFFF	ADAPTADOR RETO FÊMEA NPT X FÊMEA NPT	82
AD90FFFF	ADAPTADOR CURVA 90° FÊMEA NPT X FÊMEA NPT	82

ADAPTADORES
PAG. 59

<i>CODIGO</i>	<i>PRODUTO</i>	<i>PAG.</i>
ADMPMJ	ADAPTADOR RETO MACHO NPT X MACHO JIC 37°	83
AD45MPMJ	ADAPTADOR CURVA 45° MACHO NPT X MACHO JIC 37°	84
AD90MPMJ	ADAPTADOR CURVA 90° MACHO NPT X MACHO JIC 37°	85
ADMPFJ	ADAPTADOR RETO MACHO NPT X FÊMEA JIC 37°	86
ADMBFB	ADAPTADOR RETO MACHO BSP X FÊMEA BSP COM O'RING	87
ADMBMB	ADAPTADOR RETO MACHO BSP X MACHO BSP COM O'RING	88
ADMBMSP	ADAPTADOR RETO MACHO BSP X MACHO ORFS COM O'RING	89
ADMBFSP	ADAPTADOR RETO MACHO BSP X FÊMEA ORFS COM O'RING	90
ADMSPMSP	ADAPTADOR RETO MACHO ORFS X MACHO ORFS SEDE PLANA	90
AD90MSPMSP	ADAPTADOR CURVA 90° MACHO ORFS X MACHO ORFS SEDE PLANA	91
ADMSPMSPL	ADAPTADOR RETO MACHO ORFS X MACHO ORFS PAINEL / LONGO	91
AD90MSPMSPL	ADAP. CURVA 90° MACHO ORFS X MACHO ORFS PAINEL / LONGO - COM PORCA ORIENTÁVEL	92
ADMSPFSP	ADAPTADOR RETO MACHO ORFS X FÊMEA ORFS SEDE PLANA	92
AD45MSPFSP	ADAPTADOR CURVA 45° MACHO ORFS X FÊMEA ORFS SEDE PLANA	93
AD90MSPFSP	ADAPTADOR CURVA 90° MACHO ORFS X FÊMEA ORFS SEDE PLANA	93
ADFSPFSP	ADAPTADOR RETO FÊMEA ORFS X FÊMEA ORFS SEDE PLANA	93
ADMSPMO	ADAPTADOR RETO MACHO ORFS X MACHO UNF COM O'RING	94
AD90MSPMO	ADAPTADOR CURVA 90° MACHO ORFS X MACHO UNF ORIENTÁVEL COM O'RING	95
ADMSPMP	ADAPTADOR RETO MACHO ORFS X MACHO NPT	96
ADMSPMB	ADAPTADOR RETO MACHO ORFS X MACHO BSP COM O'RING	97
ADMSPMM	ADAPTADOR RETO MACHO ORFS X MACHO MÉTRICO	98
ADTEEMJ	ADAPTADOR TEE MACHO JIC 37°	99
ADTEEMJFJC	ADAPTADOR TEE MACHO JIC 37° X FÊMEA JIC 37° CENTRAL	99
ADTEEMJFJL	ADAPTADOR TEE MACHO JIC 37° X FÊMEA JIC 37° LATERAL	100
ADTEEMJMPC	ADAPTADOR TEE MACHO JIC 37° X MACHO NPT CENTRAL	100
ADTEEMJMPL	ADAPTADOR TEE MACHO JIC 37° X MACHO NPT LATERAL	101
ADTEEMJFFC	ADAPTADOR TEE MACHO JIC 37° X FÊMEA FIXA CENTRAL	101
ADTEEMJFFL	ADAPTADOR TEE MACHO JIC 37° X FÊMEA FIXA LATERAL	102
ADTEEMJMOC	ADAPTADOR TEE MACHO JIC 37° X MACHO UNF CENTRAL ORIENTÁVEL	103
ADTEEMJMOL	ADAPTADOR TEE MACHO JIC 37° X MACHO UNF LATERAL ORIENTÁVEL	104
ADTEEMP	ADAPTADOR TEE MACHO NPT	105
ADTEEFF	ADAPTADOR TEE FÊMEA FIXA NPT	105
ADTEEMSP	ADAPTADOR TEE MACHO ORFS	105
ADTEEMSPMOC	ADAPTADOR TEE MACHO ORFS X MACHO UNF CENTRAL ORIENTÁVEL	106
ADTEEMSPMBC	ADAPTADOR TEE MACHO ORFS X MACHO BSP CENTRAL ORIENTÁVEL	107
ADMJ	TAMPÃO MACHO JIC 37° SEXTAVADO EXTERNO	108
ADFJ	TAMPÃO FÊMEA JIC 37° SEXTAVADO EXTERNO	108
ADMB	TAMPÃO MACHO BSP SEXTAVADO EXTERNO	108
ADMBSI	TAMPÃO MACHO BSP SEXTAVADO INTERNO	109
ADMSP	TAMPÃO MACHO SEDE PLANA (ORFS) SEXTAVADO EXTERNO	109
ADFSP	TAMPÃO FÊMEA SEDE PLANA (ORFS) SEXTAVADO EXTERNO	109
ADMP	TAMPÃO MACHO NPT SEXTAVADO EXTERNO	110
ADFF	TAMPÃO FÊMEA NPT SEXTAVADO EXTERNO	110
ADMOSE	TAMPÃO MACHO O`RING UNF SEXTAVADO EXTERNO	110
ADMOSI	TAMPÃO MACHO O`RING UNF SEXTAVADO INTERNO	111
ADMMSI	TAMPÃO MACHO MÉTRICO SEXTAVADO INTERNO	111
ADT	TAMPÃO PARA TUBO	112

ADAPTADORES

PAG. 59

<i>CODIGO</i>	<i>PRODUTO</i>	<i>PAG.</i>
ADMMLSE	TAMPÃO MACHO PARA TUBO SEXTAVADO EXTERNO SÉRIE LEVE	113
ADMMPSE	TAMPÃO MACHO PARA TUBO SEXTAVADO EXTERNO SÉRIE PESADA	113

CONEXÕES DIN

PAG. 115

<i>CODIGO</i>	<i>PRODUTO</i>	<i>PAG.</i>
AA	ANILHA SÉRIE LEVE	116
AA	ANILHA SÉRIE PESADA	116
PA	PORCA DIN SÉRIE LEVE	117
PA	PORCA DIN SÉRIE PESADA	117
UMA BSP	CONEXÃO RETA MACHO MÉTRICO X MACHO ROSCA BSP COM ANEL VEDAÇÃO SÉRIE LEVE	118
UMA BSP	CONEXÃO RETA MACHO MÉTRICO X MACHO ROSCA BSP COM ANEL VEDAÇÃO SÉRIE PESADA	119
UMA MM	CONEXÃO RETA MACHO MÉTRICO X MACHO ROSCA MÉTRICA COM ANEL VEDAÇÃO SÉRIE LEVE	120
UMA MM	CONEXÃO RETA MACHO MÉTRICO X MACHO ROSCA MÉTRICA COM ANEL VEDAÇÃO SÉRIE PESADA	120
UMA UNF	CONEXÃO RETA MACHO MÉTRICO X MACHO ROSCA UNF COM ANEL O'RING SÉRIE LEVE	121
UMA UNF	CONEXÃO RETA MACHO MÉTRICO X MACHO ROSCA UNF COM ANEL O'RING SÉRIE PESADA	121
UMA NPT	CONEXÃO RETA MACHO MÉTRICO X MACHO ROSCA NPT SÉRIE LEVE	122
UMA NPT	CONEXÃO RETA MACHO MÉTRICO X MACHO ROSCA NPT SÉRIE PESADA	122
UFA BSP	CONEXÃO RETA MACHO MÉTRICO X FÊMEA ROSCA BSP SÉRIE LEVE	123
UFA BSP	CONEXÃO RETA MACHO MÉTRICO X FÊMEA ROSCA BSP SÉRIE PESADA	123
UFA	CONEXÃO RETA MACHO MÉTRICO X FÊMEA ROSCA BSP SÉRIE LEVE	123
UFA NPT	CONEXÃO RETA MACHO MÉTRICO X FÊMEA ROSCA NPT SÉRIE LEVE	124
UFA NPT	CONEXÃO RETA MACHO MÉTRICO X FÊMEA ROSCA NPT SÉRIE PESADA	124
MAMA NPT	CONEXÃO RETA MACHO ROSCA NPT X FÊMEA DKO SÉRIE LEVE	125
MAMA NPT	CONEXÃO RETA MACHO ROSCA NPT X FÊMEA DKO SÉRIE PESADA	125
MAMA BSP	CONEXÃO RETA MACHO ROSCA BSP COM ANEL DE VEDAÇÃO X FÊMEA DKO SÉRIE LEVE	126
MAMA BSP	CONEXÃO RETA MACHO ROSCA BSP COM ANEL DE VEDAÇÃO X FÊMEA DKO SÉRIE PESADA	126
MAMA MM	CONEXÃO RETA MACHO ROSCA MÉTRICA COM ANEL DE VEDAÇÃO X FÊMEA DKO SÉRIE LEVE	127
MAMA MM	CONEXÃO RETA MACHO ROSCA MÉTRICA COM ANEL DE VEDAÇÃO X FÊMEA DKO SÉRIE PESADA	127
JMA	CONEXÃO 90° ROSCA NPT SÉRIE LEVE	128
JMA	CONEXÃO 90° ROSCA NPT SÉRIE PESADA	128
TMA	CONEXÃO TEE MACHO CENTRAL ROSCA NPT SÉRIE LEVE	129
TMA	CONEXÃO TEE MACHO CENTRAL ROSCA NPT SÉRIE PESADA	129
TVA NPT	CONEXÃO TEE MACHO LATERAL ROSCA NPT SÉRIE LEVE	130
TVA NPT	CONEXÃO TEE MACHO LATERAL ROSCA NPT SÉRIE PESADA	130
TVA BSP	CONEXÃO TEE LATERAL MACHO ROSCA BSP ORIENTÁVEL SÉRIE LEVE	131
TVA BSP	CONEXÃO TEE LATERAL MACHO ROSCA BSP ORIENTÁVEL SÉRIE PESADA	131
UDA	CONEXÃO IGUAL RETA SÉRIE LEVE	132
UDA	CONEXÃO IGUAL RETA SÉRIE PESADA	132
UCA	CONEXÃO IGUAL RETA PAINEL	133
JCA	CONEXÃO IGUAL 90° PAINEL	133
JIA	CONEXÃO IGUAL 90°	134
TIA	CONEXÃO TEE IGUAL	134

CONEXÕES DIN
PAG. 115

<i>CODIGO</i>	<i>PRODUTO</i>	<i>PAG.</i>
UDRA	CONEXÃO REDUÇÃO RETA	135
MJLA	CONEXÃO 90° FÊMEA DKO	135
MTVLA	CONEXÃO TEE LATERAL FÊMEA DKO	136
MTLA	CONEXÃO TEE CENTRAL FÊMEA DKO	136
MATA	CONEXÃO REDUÇÃO RETA MACHO X FÊMEA SÉRIE LEVE	137
MATA	CONEXÃO REDUÇÃO RETA MACHO X FÊMEA SÉRIE PESADA	137
MALA	CONEXÃO EMENDA DKO	137
JOA BSP	CONEXÃO 90° MACHO ORIENTÁVEL ROSCA BSP SÉRIE LEVE	138
JOA BSP	CONEXÃO 90° MACHO ORIENTÁVEL ROSCA BSP SÉRIE PESADA	138
JOA UNF	CONEXÃO 90° MACHO ORIENTÁVEL ROSCA UNF SÉRIE LEVE	139
JOA UNF	CONEXÃO 90° MACHO ORIENTÁVEL ROSCA UNF SÉRIE PESADA	139

ACESSÓRIOS
PAG. 141

<i>CODIGO</i>	<i>PRODUTO</i>	<i>PAG.</i>
FLSPLIT3	SPLIT FLANGE COD. 61	142
FLSPLIT6	SPLIT FLANGE COD. 62	142

MANGUEIRAS
PAG. 143

<i>CODIGO</i>	<i>PRODUTO</i>	<i>PAG.</i>
100R1	SAE 100 R1AT/1SN ISO1436-1 - EN 853	144
100R2	SAE 100 R2AT/2SN ISO1436-1 - EN 853	144
100R3	SAE 100R3	145
100R5	SAE 100R5	145
100R6	SAE 100R6	146
100R7 / 100R8	SAE 100R7 / SAE 100R8	146
100R7 Laranja	SAE 100R7 Laranja	147
100R12	SAE 100R12	147
100R13	SAE 100R13	148
100R15	SAE 100R15	148
100R17	SAE 100R17	149
ASP	DIN EN 856 4SP	149
4SH	DIN EN 856 4SH	150
100R14	SAE 100R14	150
Multi Purpose	Mangueira Multi Uso 100% Borracha	151
Freio Hidráulico - J1401	Mangueira para Freio Hidráulico	151
Direção Hidráulica - J2050	Mangueira para Direção Hidráulica	152



Terminais **Standard**

CTM

CAPA Prensada para Mangueira R7/R8 (NO SKIVE)

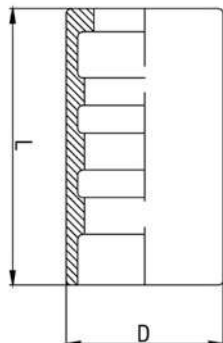

COD. ARAFLEX	MANGUEIRA		
	DN	TRAÇO	POL.
CTM-02	04	02	1/8"
CTM-04	06	04	1/4"
CTM-05	08	05	5/16"
CTM-06	10	06	3/8"
CTM-08	12	08	1/2"

CPTF

CAPA Prensada para Mangueira Teflon®/SAE100R14 (NO SKIVE)

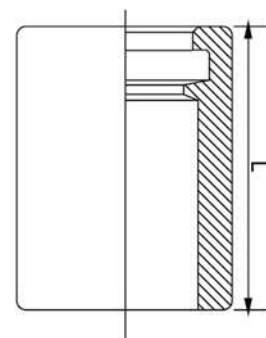

COD. ARAFLEX	MANGUEIRA		
	DN	TRAÇO	POL.
CPTF-03	04	03	3/16"
CPTF-04	06	04	1/4"
CPTF-05	08	05	5/16"
CPTF-06	10	06	3/8"
CPTF-08	12	08	1/2"
CPTF-10	16	10	5/8"
CPTF-12	20	12	3/4"

CPT2210

CAPA Prensada para Mangueira SAE100 R2AT (NO SKIVE)

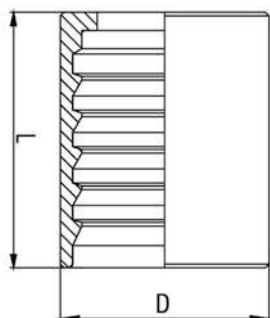

COD. ARAFLEX	MANGUEIRA		
	DN	TRAÇO	POL.
CPT2210-04	06	04	1/4"
CPT2210-06	10	06	3/8"
CPT2210-08	12	08	1/2"
CPT2210-10	16	10	5/8"
CPT2210-12	20	12	3/4"
CPT2210-16	25	16	1"
CPT2210-20	32	20	1.1/4"
CPT2210-24	40	24	1.1/2"
CPT2210-32	50	32	2"

CSD

CAPA Prensada para Mangueira SAE100 R1AT/R2AT (NO SKIVE)

COD. ARAFLEX	MANGUEIRA		
	DN	TRAÇO	POL.
CSD-03	05	03	3/16"
CSD-04	06	04	1/4"
CSD-05	08	05	5/16"
CSD-06	10	06	3/8"
CSD-08	12	08	1/2"
CSD-10	16	10	5/8"
CSD-12	20	12	3/4"
CSD-16	25	16	1"
CSD-20	32	20	1.1/4"
CSD-24	40	24	1.1/2"
CSD-32	50	32	2"

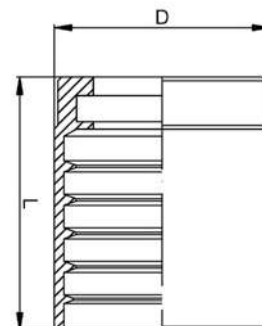

CCD

CAPA Prensada para Mangueira R12 / 4SP / 4SH (SKIVE)

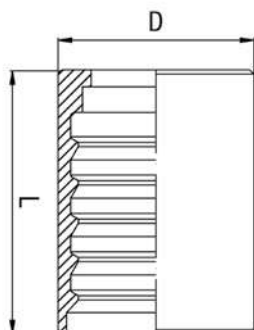

COD. ARAFLEX	MANGUEIRA		
	DN	TRAÇO	POL.
CCD-04	06	04	1/4"
CCD-06	10	06	3/8"
CCD-08	12	08	1/2"
CCD-10	16	10	5/8"
CCD-12	20	12	3/4"
CCD-16	25	16	1"
CCD-20	32	20	1.1/4"
CCD-24	40	24	1.1/2"
CCD-32	50	32	2"

CPR

CAPA Prensada RAIADA para Mangueira R12 / 4SH (SKIVE)

COD. ARAFLEX	MANGUEIRA		
	DN	TRAÇO	POL.
CPR-08	12	08	1/2"
CPR-10	16	10	5/8"
CPR-12	20	12	3/4"
CPR-16	25	16	1"
CPR-20	32	20	1.1/4"
CPR-24	40	24	1.1/2"
CPR-32	50	32	2"

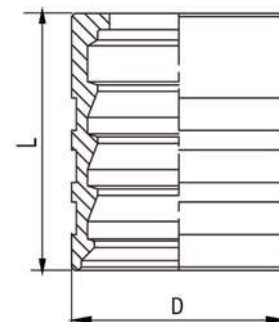

TMJ

MACHO FIXO UNF JIC 37° SAE J514

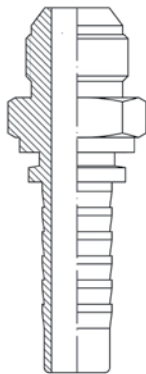

COD. ARAFLEX	ROSCA	MANGUEIRA		
		DN	TRAÇO	POL.
TMJ-04-04	7/16"X20	06	04	1/4"
TMJ-05-04	1/2"X20	06	04	1/4"
TMJ-06-04	9/16"X18	06	04	1/4"
TMJ-06-06	9/16"X18	10	06	3/8"
TMJ-06-08	9/16"X18	12	08	1/2"
TMJ-08-06	3/4"X16	10	06	3/8"
TMJ-08-08	3/4"X16	12	08	1/2"
TMJ-10-06	7/8"X14	10	06	3/8"
TMJ-10-08	7/8"X14	12	08	1/2"
TMJ-10-10	7/8"X18	16	10	5/8"
TMJ-12-08	1.1/16"X12	12	08	1/2"
TMJ-12-10	1.1/16"X12	16	10	5/8"
TMJ-12-12	1.1/16"X12	20	12	3/4"
TMJ-12-16	1.1/16"X12	25	16	1"
TMJ-14-12	1.3/16"X12	20	12	3/4"
TMJ-16-12	1.5/16"X12	20	12	3/4"
TMJ-16-16	1.5/16"X12	25	16	1"
TMJ-20-16	1.5/8"X12	25	16	1"
TMJ-20-20	1.5/8"X12	32	20	1.1/4"
TMJ-24-20	1.7/8"X12	32	20	1.1/4"
TMJ-24-24	1.7/8"X12	40	24	1.1/2"
TMJ-32-24	2.1/2"X12	40	24	1.1/2"
TMJ-32-32	2.1/2"X12	50	32	2"

TFGJ

FÊMEA GIRATÓRIA RETA UNF JIC 37° SAE J514

COD. ARAFLEX	ROSCA	MANGUEIRA		
		DN	TRAÇO	POL.
TFGJ-04-04	7/16"X20	06	04	1/4"
TFGJ-04-06	7/16"X20	10	06	3/8"
TFGJ-05-04	1/2"X20	06	04	1/4"
TFGJ-05-06	1/2"X20	10	06	3/8"
TFGJ-06-04	9/16"X18	06	04	1/4"
TFGJ-06-06	9/16"X18	10	06	3/8"
TFGJ-06-08	9/16"X18	12	08	1/2"
TFGJ-08-04	3/4"X16	06	04	1/4"
TFGJ-08-06	3/4"X16	10	06	3/8"
TFGJ-08-08	3/4"X16	12	08	1/2"
TFGJ-08-10	3/4"X16	16	10	5/8"
TFGJ-08-12	3/4"X16	20	12	3/4"
TFGJ-10-06	7/8"X14	10	06	3/8"
TFGJ-10-08	7/8"X14	12	08	1/2"
TFGJ-10-10	7/8"X14	16	10	5/8"
TFGJ-10-12	7/8"X14	20	12	3/4"
TFGJ-12-08	1.1/16"X12	12	08	1/2"
TFGJ-12-10	1.1/16"X12	16	10	5/8"
TFGJ-12-12	1.1/16"X12	20	12	3/4"
TFGJ-12-16	1.1/16"X12	25	16	1"
TFGJ-14-12	1.3/16"X12	20	12	3/4"
TFGJ-16-12	1.5/16"X12	20	12	3/4"
TFGJ-16-16	1.5/16"X12	25	16	1"
TFGJ-16-20	1.5/16"X12	32	20	1.1/4"
TFGJ-20-16	1.5/8"X12	25	16	1"
TFGJ-20-20	1.5/8"X12	32	20	1.1/4"
TFGJ-24-20	1.7/8"X12	32	20	1.1/4"
TFGJ-24-24	1.7/8"X12	40	24	1.1/2"
TFGJ-32-24	2.1/2"X12	40	24	1.1/2"
TFGJ-32-32	2.1/2"X12	50	32	2"

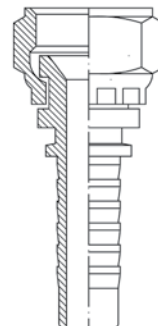

TFGJ45

FÊMEA GIRATÓRIA CURVA 45° UNF JIC 37° SAE J514

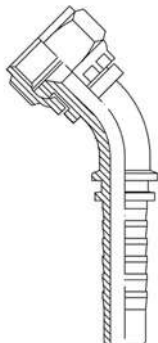

COD. ARAFLEX	ROSCA	MANGUEIRA		
		DN	TRAÇO	POL.
TFGJ45-04-04	7/16"X20	06	04	1/4"
TFGJ45-05-04	1/2"X20	06	04	1/4"
TFGJ45-05-06	1/2"X20	10	06	3/8"
TFGJ45-06-04	9/16"X18	06	04	1/4"
TFGJ45-06-06	9/16"X18	10	06	3/8"
TFGJ45-08-06	3/4"X16	10	06	3/8"
TFGJ45-08-08	3/4"X16	12	08	1/2"
TFGJ45-10-06	7/8"X14	10	06	3/8"
TFGJ45-10-08	7/8"X14	12	08	1/2"
TFGJ45-10-10	7/8"X14	16	10	5/8"
TFGJ45-10-12	7/8"X14	20	12	3/4"
TFGJ45-12-08	1.1/16"X12	12	08	1/2"
TFGJ45-12-10	1.1/16"X12	16	10	5/8"
TFGJ45-12-12	1.1/16"X12	20	12	3/4"
TFGJ45-14-12	1.3/16"X12	20	12	3/4"
TFGJ45-16-12	1.5/16"X12	20	12	3/4"
TFGJ45-16-16	1.5/16"X12	25	16	1"
TFGJ45-20-16	1.5/8"X12	25	16	1"
TFGJ45-20-20	1.5/8"X12	32	20	1.1/4"
TFGJ45-24-20	1.7/8"X12	32	20	1.1/4"
TFGJ45-24-24	1.7/8"X12	40	24	1.1/2"
TFGJ45-32-32	2.1/2"X12	50	32	2"

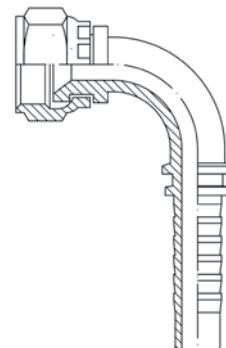
TFGJ90
**FÊMEA GIRATÓRIA CURVA 90° UNF JIC 37°
SAE J514**

COD. ARAFLEX	ROSCA	MANGUEIRA		
		DN	TRAÇO	POL.
TFGJ90-04-04	7/16"X20	06	04	1/4"
TFGJ90-04-06	7/16"X20	10	06	3/8"
TFGJ90-05-04	1/2"X20	06	04	1/4"
TFGJ90-05-06	1/2"X20	10	06	3/8"
TFGJ90-06-04	9/16"X18	06	04	1/4"
TFGJ90-06-06	9/16"X18	10	06	3/8"
TFGJ90-08-04	3/4"X16	06	04	1/4"
TFGJ90-08-06	3/4"X16	10	06	3/8"
TFGJ90-08-08	3/4"X16	12	08	1/2"
TFGJ90-08-08	3/4"X16	12	08	1/2"
TFGJ90-10-06	7/8"X14	10	06	3/8"
TFGJ90-10-08	7/8"X14	12	08	1/2"
TFGJ90-10-10	7/8"X14	16	10	5/8"
TFGJ90-10-12	7/8"X14	20	12	3/4"
TFGJ90-12-08	1.1/16"X12	12	08	1/2"
TFGJ90-12-10	1.1/16"X12	16	10	5/8"
TFGJ90-12-12	1.1/16"X12	20	12	3/4"
TFGJ90-14-12	1.3/16"X12	20	12	3/4"
TFGJ90-16-12	1.5/16"X12	20	12	3/4"
TFGJ90-16-16	1.5/16"X12	25	16	1"
TFGJ90-20-16	1.5/8"X12	25	16	1"
TFGJ90-20-20	1.5/8"X12	32	20	1.1/4"
TFGJ90-24-20	1.7/8"X12	32	20	1.1/4"
TFGJ90-24-24	1.7/8"X12	40	24	1.1/2"
TFGJ90-32-32	2.1/2"X12	50	32	2"

TFGJ90L

FÊMEA GIRATÓRIA CURVA 90° LONGA UNF JIC 37°
SAE J514

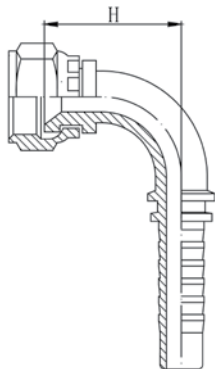

COD. ARAFLEX	ROSCA	MANGUEIRA		
		DN	TRAÇO	POL.
TFGJ90L-04-04	7/16"X20	06	04	1/4"
TFGJ90L-05-04	1/2"X20	06	04	1/4"
TFGJ90L-06-04	9/16"X18	06	04	1/4"
TFGJ90L-08-06	3/4"X16	10	06	3/8"
TFGJ90L-08-08	3/4"X16	12	08	1/2"
TFGJ90L-10-08	7/8"X14	12	08	1/2"
TFGJ90L-10-10	7/8"X14	16	10	5/8"
TFGJ90L-12-12	1.1/16"X12	20	12	3/4"
TFGJ90L-16-12	1.5/16"X12	20	12	3/4"
TFGJ90L-16-16	1.5/16"X12	25	16	1"
TFGJ90L-20-20	1.5/8"X12	32	20	1.1/4"

TFGJS

FÊMEA GIRATÓRIA RETA UNF JIC 45°
SAE J514

COD. ARAFLEX	ROSCA	MANGUEIRA		
		DN	TRAÇO	POL.
TFGJS-06-06	9/16"X18	10	06	3/8"
TFGJS-12-12	1.1/16"X12	20	12	3/4"

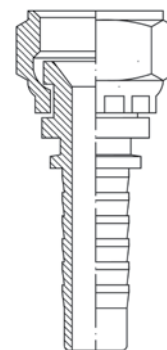

TFGJS90

FÊMEA GIRATÓRIA CURVA 90° UNF JIC 45°
SAE J514

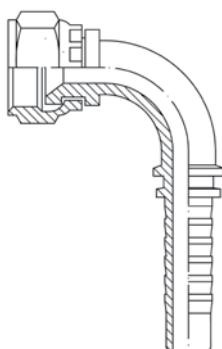

COD. ARAFLEX	ROSCA	MANGUEIRA		
		DN	TRAÇO	POL.
TFGJS90-06-06	9/16"X18	10	06	3/8"
TFGJS90-12-12	1.1/16"X12	20	12	3/4"

TMFKT

MACHO FIXO MÉTRICO KOMATSU SEDE 60°/JIS B8363

COD. ARAFLEX	ROSCA	MANGUEIRA		
		DN	TRAÇO	POL.
TMFKT-22-10	M22X1.5	16	10	5/8"
TMFKT-24-08	M24X1.5	12	08	1/2"
TMFKT-24-10	M24X1.5	16	10	5/8"
TMFKT-24-12	M24X1.5	20	12	3/4"

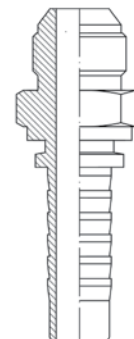

TFGKT

FÊMEA GIRATÓRIA MÉTRICA KOMATSU SEDE 60°/JIS B8363

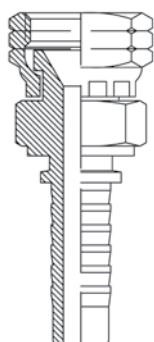

COD. ARAFLEX	ROSCA	MANGUEIRA		
		DN	TRAÇO	POL.
TFGKT-14-04	M14X1.5	06	04	1/4"
TFGKT-14-06	M14X1.5	10	06	3/8"
TFGKT-18-04	M18X1.5	06	04	1/4"
TFGKT-18-06	M18X1.5	10	06	3/8"
TFGKT-22-08	M22X1.5	12	08	1/2"
TFGKT-24-08	M24X1.5	12	08	1/2"
TFGKT-24-10	M24X1.5	16	10	5/8"
TFGKT-24-12	M24X1.5	20	12	3/4"
TFGKT-26-10	M26X1.5	16	10	5/8"
TFGKT-30-12	M30X1.5	20	12	3/4"
TFGKT-33-16	M33X1.5	16	10	5/8"
TFGKT-36-20	M36X1.5	32	20	1.1/4"
TFGKT-42-24	M42X1.5	40	24	1.1/2"

TFGKT90

FÊMEA GIRATÓRIA CURVA 90° MÉTRICA KOMATSU SEDE 60°/JIS B8363

COD. ARAFLEX	ROSCA	MANGUEIRA		
		DN	TRAÇO	POL.
TFGKT90-14-04	M14X1.5	06	04	1/4"
TFGKT90-18-06	M18X1.5	10	06	3/8"
TFGKT90-22-08	M22X1.5	12	08	1/2"
TFGKT90-24-10	M24X1.5	16	10	5/8"
TFGKT90-30-12	M30X1.5	20	12	3/4"
TFGKT90-33-16	M33X1.5	25	16	1"

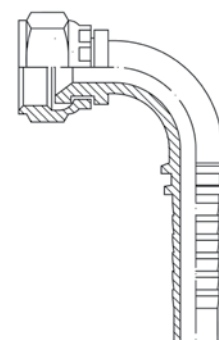

TMFM

MACHO MÉTRICO PARA TUBO - SÉRIE LEVE SEDE 24°/DIN 3853 - 3861

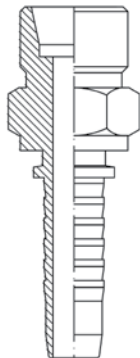

COD. ARAFLEX	ROSCA	DN TUBO	MANGUEIRA		
			DN	TRAÇO	POL.
TMFM-12-06-04	M12X1.5	06	06	04	1/4"
TMFM-14-08-04	M14X1.5	08	06	04	1/4"
TMFM-16-10-04	M16X1.5	10	06	04	1/4"
TMFM-16-10-06	M16X1.5	10	10	06	3/8"
TMFM-18-12-04	M18X1.5	12	06	04	1/4"
TMFM-18-12-06	M18X1.5	12	10	06	3/8"
TMFM-18-12-08	M18X1.5	12	12	08	1/2"
TMFM-22-15-06	M22X1.5	15	10	06	3/8"
TMFM-22-15-08	M22X1.5	15	12	08	1/2"
TMFM-22-15-10	M22X1.5	15	16	10	5/8"
TMFM-26-18-08	M26X1.5	18	12	08	1/2"
TMFM-26-18-10	M26X1.5	18	16	10	5/8"
TMFM-27-18-08	M27X1.5	18	12	08	1/2"
TMFM-27-18-10	M27X1.5	18	16	10	5/8"
TMFM-30-22-12	M30X2	22	20	12	3/4"
TMFM-34-25-12	M34X2	25	20	12	3/4"
TMFM-34-25-16	M34X2	25	25	16	1"
TMFM-36-28-12	M36X2	28	20	12	3/4"
TMFM-36-28-16	M36X2	28	25	16	1"
TMFM-45-35-20	M45X2	35	32	20	1.1/4"
TMFM-48-38-20	M48X2	38	32	20	1.1/4"
TMFM-52-42-24	M52X2	42	40	24	1.1/2"

TMFM
MACHO MÉTRICO PARA TUBO - SÉRIE PESADA
SEDE 24°/DIN 3853 - 3861

COD. ARAFLEX	ROSCA	DN TUBO	MANGUEIRA		
			DN	TRAÇO	POL.
TMFM-14-06-04	M14X1.5	06	06	04	1/4"
TMFM-16-08-04	M16X1.5	08	06	04	1/4"
TMFM-18-10-04	M18X1.5	10	06	04	1/4"
TMFM-18-10-06	M18X1.5	10	10	04	3/8"
TMFM-20-12-06	M20X1.5	12	10	04	3/8"
TMFM-20-12-08	M20X1.5	12	12	08	1/2"
TMFM-22-14-06	M22X1.5	14	10	06	3/8"
TMFM-22-14-08	M22X1.5	14	12	08	1/2"
TMFM-24-16-08	M24X1.5	16	12	08	1/2"
TMFM-28-19-10	M28X1.5	19	16	10	5/8"
TMFM-28-19-12	M28X1.5	19	20	12	3/4"
TMFM-30-20-10	M30X2	20	16	10	5/8"
TMFM-30-20-12	M30X2	20	20	12	3/4"
TMFM-36-25-12	M36X2	25	20	12	3/4"
TMFM-36-25-16	M36X2	25	25	16	1"
TMFM-42-30-20	M42X2	30	32	20	1.1/4"
TMFM-52-38-20	M52X2	38	32	20	1.1/4"

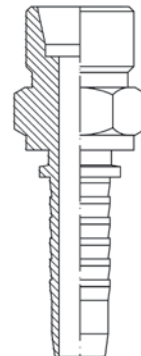

TDKO

FÊMEA GIRATÓRIA MÉTRICA RETA DKO - SÉRIE LEVE SEDE 24°/DIN 3865

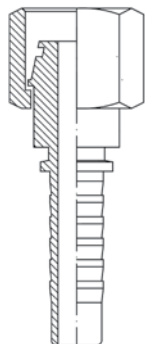

COD. ARAFLEX	ROSCA	DN TUBO	MANGUEIRA		
			DN	TRAÇO	POL.
TDKO-12-06-04	M12X1.5	06	06	04	1/4"
TDKO-14-08-04	M14X1.5	08	06	04	1/4"
TDKO-14-08-06	M14X1.5	08	10	06	3/8"
TDKO-16-10-04	M16X1.5	10	06	04	1/4"
TDKO-16-10-06	M16X1.5	10	10	06	3/8"
TDKO-18-12-04	M18X1.5	12	06	04	1/4"
TDKO-18-12-06	M18X1.5	12	10	06	3/8"
TDKO-22-15-06	M22X1.5	15	10	06	3/8"
TDKO-22-15-08	M22X1.5	15	12	08	1/2"
TDKO-22-15-10	M22X1.5	15	16	10	5/8"
TDKO-26-18-08	M26X1.5	18	12	08	1/2"
TDKO-26-18-10	M26X1.5	18	16	10	5/8"
TDKO-26-18-12	M26X1.5	18	20	12	3/4"
TDKO-30-22-10	M30X2	22	16	10	5/8"
TDKO-30-22-12	M30X2	22	20	12	3/4"
TDKO-34-25-12	M34X2	25	20	12	3/4"
TDKO-34-25-16	M34X2	25	25	16	1"
TDKO-36-28-12	M36X2	28	20	12	3/4"
TDKO-36-28-16	M36X2	28	25	16	1"
TDKO-45-35-20	M45X2	35	32	20	1.1/4"
TDKO-45-35-24	M45X2	35	40	24	1.1/2"
TDKO-48-38-24	M48X2	38	40	24	1.1/2"
TDKO-52-42-20	M52X2	42	32	20	1.1/4"
TDKO-52-42-24	M52X2	42	40	24	1.1/2"
TDKO-52-42-32	M52X2	42	50	32	2"

TDKO
FÊMEA GIRATÓRIA MÉTRICA RETA DKO - SÉRIE PESADA
SEDE 24°/DIN 3865

COD. ARAFLEX	ROSCA	DN TUBO	MANGUEIRA		
			DN	TRAÇO	POL.
TDKO-14-06-04	M14X1.5	06	06	04	1/4"
TDKO-16-08-04	M16X1.5	08	06	04	1/4"
TDKO-18-10-04	M18X1.5	10	06	04	1/4"
TDKO-18-10-06	M18X1.5	10	10	06	3/8"
TDKO-20-12-04	M20X1.5	12	06	04	1/4"
TDKO-20-12-06	M20X1.5	12	10	06	3/8"
TDKO-20-12-08	M20X1.5	12	12	08	1/2"
TDKO-22-14-06	M22X1.5	14	10	06	3/8"
TDKO-22-14-08	M22X1.5	14	12	08	1/2"
TDKO-24-16-06	M24X1.5	16	10	06	3/8"
TDKO-24-16-08	M24X1.5	16	12	08	1/2"
TDKO-24-16-10	M24X1.5	16	16	10	5/8"
TDKO-24-16-12	M24X1.5	16	20	12	3/4"
TDKO-28-19-10	M28X1.5	19	16	10	5/8"
TDKO-28-19-12	M28X1.5	19	20	12	3/4"
TDKO-30-20-10	M30X2	20	16	10	5/8"
TDKO-30-20-12	M30X2	20	20	12	3/4"
TDKO-36-25-12	M36X2	25	20	12	3/4"
TDKO-36-25-16	M36X2	25	25	16	1"
TDKO-42-30-16	M42X2	30	25	16	1"
TDKO-42-30-20	M42X2	30	32	20	1.1/4"
TDKO-52-38-16	M52X2	38	25	16	1"
TDKO-52-38-20	M52X2	38	32	20	1.1/4"
TDKO-52-38-24	M52X2	38	40	24	1.1/2"

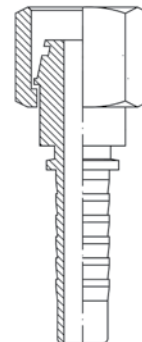

TDKO45

FÊMEA GIRATÓRIA MÉTRICA CURVA 45° DKO - SÉRIE LEVE SEDE 24°/DIN 3865

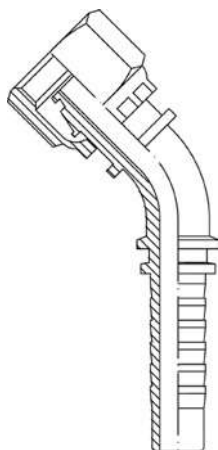

COD. ARAFLEX	ROSCA	DN TUBO	MANGUEIRA		
			DN	TRAÇO	POL.
TDKO45-12-06-04	M12X1.5	06	06	04	1/4"
TDKO45-14-08-04	M14X1.5	08	06	04	1/4"
TDKO45-16-10-04	M16X1.5	10	06	04	1/4"
TDKO45-16-10-06	M16X1.5	10	10	06	3/8"
TDKO45-18-12-04	M18X1.5	12	06	04	1/4"
TDKO45-18-12-06	M18X1.5	12	10	06	3/8"
TDKO45-22-15-06	M22X1.5	15	10	06	3/8"
TDKO45-22-15-08	M22X1.5	15	12	08	1/2"
TDKO45-26-18-10	M26X1.5	18	16	10	5/8"
TDKO45-30-22-10	M30X2	22	16	10	5/8"
TDKO45-36-28-16	M36X2	28	25	16	1"
TDKO45-36-28-20	M36X2	28	32	20	1.1/4"
TDKO45-45-35-20	M45X2	35	32	20	1.1/4"
TDKO45-52-42-24	M52X2	42	40	24	1.1/2"

TDKO45

FÊMEA GIRATÓRIA MÉTRICA CURVA 45° DKO - SÉRIE PESADA SEDE 24°/DIN 3865

COD. ARAFLEX	ROSCA	DN TUBO	MANGUEIRA		
			DN	TRAÇO	POL.
TDKO45-16-08-04	M16X1.5	08	06	04	1/4"
TDKO45-18-10-04	M18X1.5	10	06	04	1/4"
TDKO45-20-12-06	M20X1.5	12	10	06	3/8"
TDKO45-22-14-06	M22X1.5	14	10	06	3/8"
TDKO45-24-16-08	M24X1.5	16	12	08	1/2"
TDKO45-30-20-10	M30X2	20	16	10	5/8"
TDKO45-30-20-12	M30X2	20	20	12	3/4"
TDKO45-36-25-12	M36X2	25	20	12	3/4"
TDKO45-36-25-16	M36X2	25	25	16	1"
TDKO45-42-30-16	M42X2	30	25	16	1"
TDKO45-42-30-20	M42X2	30	32	20	1.1/4"
TDKO45-52-38-20	M52X2	38	32	20	1.1/4"
TDKO45-52-38-24	M52X2	38	40	24	1.1/2"

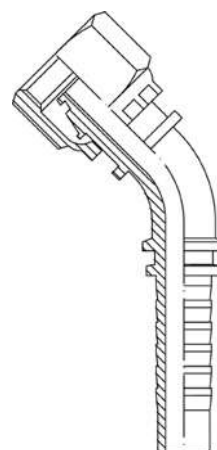

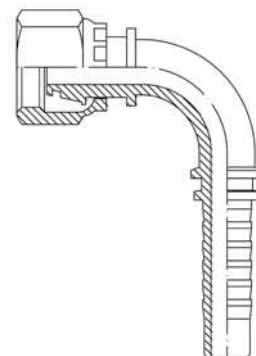
TDKO90
**FÊMEA GIRATÓRIA MÉTRICA CURVA 90° DKO - SÉRIE LEVE
SEDE 24°/DIN 3865**

COD. ARAFLEX	ROSCA	DN TUBO	MANGUEIRA		
			DN	TRAÇO	POL.
TDKO90-12-06-04	M12X1.5	06	06	04	1/4"
TDKO90-14-08-04	M14X1.5	08	06	04	1/4"
TDKO90-14-08-06	M14X1.5	08	10	06	3/8"
TDKO90-16-10-04	M16X1.5	10	06	04	1/4"
TDKO90-16-10-06	M16X1.5	10	10	06	3/8"
TDKO90-18-12-04	M18X1.5	12	06	04	1/4"
TDKO90-18-12-06	M18X1.5	12	10	06	3/8"
TDKO90-18-12-08	M18X1.5	12	12	08	1/2"
TDKO90-22-15-06	M22X1.5	15	10	06	3/8"
TDKO90-22-15-08	M22X1.5	15	12	08	1/2"
TDKO90-22-15-10	M22X1.5	15	16	10	5/8"
TDKO90-26-18-08	M26X1.5	18	12	08	1/2"
TDKO90-26-18-10	M26X1.5	18	16	10	5/8"
TDKO90-30-22-10	M30X2	22	16	10	5/8"
TDKO90-30-22-12	M30X2	22	20	12	3/4"
TDKO90-34-25-12	M34X2	25	20	12	3/4"
TDKO90-34-25-16	M34X2	25	25	16	1"
TDKO90-36-28-16	M36X2	28	25	16	1"
TDKO90-45-35-20	M45X2	35	32	20	1.1/4"
TDKO90-52-42-24	M52X2	42	40	24	1.1/2"

TDKO90

FÊMEA GIRATÓRIA MÉTRICA CURVA 90° DKO - SÉRIE PESADA SEDE 24°/DIN 3865

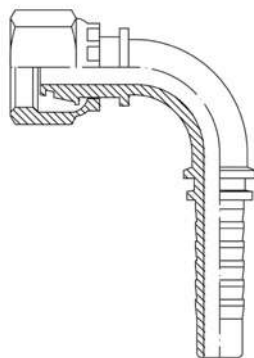

COD. ARAFLEX	ROSCA	DN TUBO	MANGUEIRA		
			DN	TRAÇO	POL.
TDKO90-14-06-04	M14X1.5	06	06	04	1/4"
TDKO90-16-08-04	M16X1.5	08	06	04	1/4"
TDKO90-18-10-04	M18X1.5	10	06	04	1/4"
TDKO90-18-10-06	M18X1.5	10	10	06	3/8"
TDKO90-18-10-08	M18X1.5	10	12	08	1/2"
TDKO90-20-12-04	M20X1.5	12	06	04	1/4"
TDKO90-20-12-06	M20X1.5	12	10	06	3/8"
TDKO90-20-12-08	M20X1.5	12	12	08	1/2"
TDKO90-22-14-06	M22X1.5	14	10	06	3/8"
TDKO90-24-16-06	M24X1.5	16	10	06	3/8"
TDKO90-24-16-08	M24X1.5	16	12	08	1/2"
TDKO90-24-16-10	M24X1.5	16	16	10	5/8"
TDKO90-30-20-10	M30X2	20	16	10	5/8"
TDKO90-30-20-12	M30X2	20	20	12	3/4"
TDKO90-36-25-12	M36X2	25	20	12	3/4"
TDKO90-36-25-16	M36X2	25	25	16	1"
TDKO90-42-30-16	M42X2	30	25	16	1"
TDKO90-52-38-20	M52X2	38	32	20	1.1/4"
TDKO90-52-38-24	M52X2	38	40	24	1.1/2"

TMFPC**MACHO RETO MÉTRICO POCLAIN
SEDE 24°/ROSCA MÉTRICA FINA**

COD. ARAFLEX	ROSCA	DN TUBO	MANGUEIRA		
			DN	TRAÇO	POL.
TMFPC-24-17-08	M24X1.5	17	12	08	1/2"
TMFPC-30-21-10	M30X1.5	21	16	10	5/8"
TMFPC-36-27-12	M36X1.5	27	20	12	3/4"

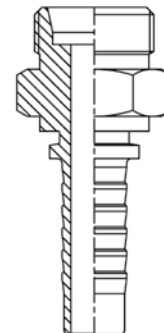
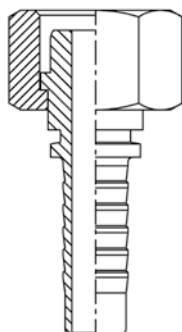
**TFGPC****FÊMEA MÉTRICA POCLAIN
SEDE 24°/ROSCA MÉTRICA FINA**

COD. ARAFLEX	ROSCA	DN TUBO	MANGUEIRA		
			DN	TRAÇO	POL.
TFGPC-24-17-08	M24X1.5	17	12	08	1/2"
TFGPC-30-21-10	M30X1.5	21	16	10	5/8"
TFGPC-36-27-12	M36X1.5	27	20	12	3/4"

TMFP

MACHO FIXO NPT SEDE 60°/SAE J516

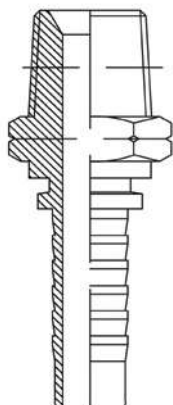

COD. ARAFLEX	ROSCA	MANGUEIRA		
		DN	TRAÇO	POL.
TMFP-02-04	1/8"X27	06	04	1/4"
TMFP-04-04	1/4"X18	06	04	1/4"
TMFP-04-06	1/4"X18	10	06	3/8"
TMFP-04-08	1/4"X18	12	08	1/2"
TMFP-06-04	3/8"X18	06	04	1/4"
TMFP-06-06	3/8"X18	10	06	3/8"
TMFP-06-08	3/8"X18	12	08	1/2"
TMFP-08-04	1/2"X14	06	04	1/4"
TMFP-08-06	1/2"X14	10	06	3/8"
TMFP-08-08	1/2"X14	12	08	1/2"
TMFP-08-10	1/2"X14	16	10	5/8"
TMFP-08-12	1/2"X14	20	12	3/4"
TMFP-12-08	3/4"X14	12	08	1/2"
TMFP-12-10	3/4"X14	16	10	5/8"
TMFP-12-12	3/4"X14	20	12	3/4"
TMFP-16-10	1"X11.5	16	10	5/8"
TMFP-16-12	1"X11.5	20	12	3/4"
TMFP-16-16	1"X11.5	25	16	1"
TMFP-20-16	1.1/4"X11.5	25	16	1"
TMFP-20-20	1.1/4"X11.5	32	20	1.1/4"
TMFP-24-20	1.1/2"X11.5	32	20	1.1/4"
TMFP-24-24	1.1/2"X11.5	40	24	1.1/2"
TMFP-32-24	2"X11.5	40	24	1.1/2"
TMFP-32-32	2"X11.5	50	32	2"

TFFP

FÊMEA FIXA NPT

COD. ARAFLEX	ROSCA	MANGUEIRA		
		DN	TRAÇO	POL.
TFFP-02-04	1/8"-27	06	04	1/4"
TFFP-04-04	1/4"X18	06	04	1/4"
TFFP-06-04	3/8"X18	06	04	1/4"
TFFP-06-06	3/8"X18	10	06	3/8"

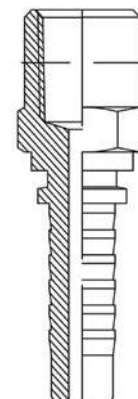

TMFO

MACHO FIXO O'RING - UNF SAE J512

COD. ARAFLEX	ROSCA	MANGUEIRA		
		DN	TRAÇO	POL.
TMFO-04-04	7/16"X20	06	04	1/4"
TMFO-06-04	9/16"X18	06	04	1/4"
TMFO-06-06	9/16"X18	10	06	3/8"
TMFO-08-06	3/4"X16	10	06	3/8"
TMFO-08-08	3/4"X16	12	08	1/2"
TMFO-10-08	7/8"X14	12	08	1/2"
TMFO-10-10	7/8"X14	16	10	5/8"
TMFO-12-08	1.1/16"X12	12	08	1/2"
TMFO-12-10	1.1/16"X12	16	10	5/8"
TMFO-12-12	1.1/16"X12	20	12	3/4"
TMFO-16-12	1.5/16"X12	20	12	3/4"
TMFO-16-16	1.5/16"X12	25	16	1"
TMFO-20-20	1.5/8"X12	32	20	1.1/4"

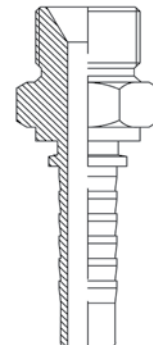

TMFSP

MACHO FIXO SEDE PLANA - ORFS SAE J1453

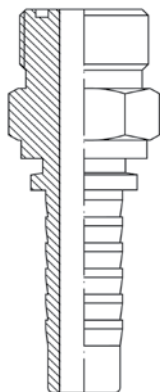

COD. ARAFLEX	ROSCA	MANGUEIRA		
		DN	TRAÇO	POL.
TMFSP-04-04	9/16"X18	06	04	1/4"
TMFSP-06-04	11/16"X16	06	04	1/4"
TMFSP-06-06	11/16"X16	10	06	3/8"
TMFSP-08-06	13/16"X16	10	06	3/8"
TMFSP-08-08	13/16"X16	12	08	1/2"
TMFSP-10-08	1"X14	12	08	1/2"
TMFSP-10-10	1"X14	16	10	5/8"
TMFSP-12-10	1.3/16"X12	16	10	5/8"
TMFSP-12-12	1.3/16"X12	20	12	3/4"
TMFSP-16-12	1.7/16"X12	20	12	3/4"
TMFSP-16-16	1.7/16"X12	25	16	1"
TMFSP-20-20	1.11/16"X12	32	20	1.1/4"
TMFSP-24-24	2"X12	40	24	1.1/2"

TFGSP

FÊMEA GIRATÓRIA RETA SEDE PLANA ORFS SAE J1453

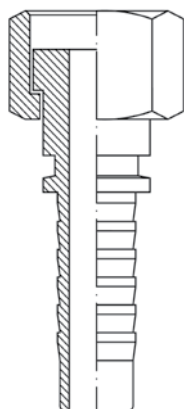

COD. ARAFLEX	ROSCA	MANGUEIRA		
		DN	TRAÇO	POL.
TFGSP-04-04	9/16"X18	06	04	1/4"
TFGSP-06-04	11/16"X16	06	04	1/4"
TFGSP-06-06	11/16"X16	10	06	3/8"
TFGSP-06-08	11/16"X16	12	08	1/2"
TFGSP-08-06	13/16"X16	10	06	3/8"
TFGSP-08-08	13/16"X16	12	08	1/2"
TFGSP-10-08	1"X14	12	08	1/2"
TFGSP-10-10	1"X14	16	10	5/8"
TFGSP-10-12	1"X14	20	12	3/4"
TFGSP-12-08	1.3/16"X12	12	08	1/2"
TFGSP-12-10	1.3/16"X12	16	10	5/8"
TFGSP-12-12	1.3/16"X12	20	12	3/4"
TFGSP-12-16	1.3/16"X12	25	16	1"
TFGSP-16-12	1.7/16"X12	20	12	3/4"
TFGSP-16-16	1.7/16"X12	25	16	1"
TFGSP-20-16	1.11/16"X12	25	16	1"
TFGSP-20-20	1.11/16"X12	32	20	1.1/4"
TFGSP-24-24	2"X12	40	24	1.1/2"

TFGSP45

FÊMEA GIRATÓRIA CURVA 45° SEDE PLANA ORFS SAE J1453

COD. ARAFLEX	ROSCA	MANGUEIRA		
		DN	TRAÇO	POL.
TFGSP45-04-04	9/16"X18	06	04	1/4"
TFGSP45-06-04	11/16"X16	06	04	1/4"
TFGSP45-06-06	11/16"X16	10	06	3/8"
TFGSP45-06-08	11/16"X16	12	08	1/2"
TFGSP45-08-06	13/16"X16	10	06	3/8"
TFGSP45-08-08	13/16"X16	12	08	1/2"
TFGSP45-10-08	1"X14	12	08	1/2"
TFGSP45-10-10	1"X14	16	10	5/8"
TFGSP45-10-12	1"X14	20	12	3/4"
TFGSP45-12-08	1.3/16"X12	12	08	1/2"
TFGSP45-12-10	1.3/16"X12	16	10	5/8"
TFGSP45-12-12	1.3/16"X12	20	12	3/4"
TFGSP45-16-12	1.7/16"X12	20	12	3/4"
TFGSP45-16-16	1.7/16"X12	25	16	1"
TFGSP45-20-16	1.11/16"X12	25	16	1"
TFGSP45-20-20	1.11/16"X12	32	20	1.1/4"
TFGSP45-24-24	2"X12	40	24	1.1/2"

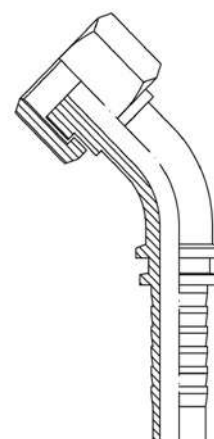

TFGSP90

FÊMEA GIRATÓRIA CURVA 90° SEDE PLANA ORFS SAE J1453

COD. ARAFLEX	ROSCA	MANGUEIRA		
		DN	TRAÇO	POL.
TFGSP90-04-04	9/16"X18	06	04	1/4"
TFGSP90-06-04	11/16"X16	06	04	1/4"
TFGSP90-06-06	11/16"X16	10	06	3/8"
TFGSP90-06-08	11/16"X16	12	08	1/2"
TFGSP90-08-06	13/16"X16	10	06	3/8"
TFGSP90-08-08	13/16"X16	12	08	1/2"
TFGSP90-10-08	1"X14	12	08	1/2"
TFGSP90-10-10	1"X14	16	10	5/8"
TFGSP90-12-08	1.3/16"X12	12	08	1/2"
TFGSP90-12-10	1.3/16"X12	16	10	5/8"
TFGSP90-12-12	1.3/16"X12	20	12	3/4"
TFGSP90-12-16	1.3/16"X12	25	16	1"
TFGSP90-16-12	1.7/16"X12	20	12	3/4"
TFGSP90-16-16	1.7/16"X12	25	16	1"
TFGSP90-20-16	1.11/16"X12	25	16	1"
TFGSP90-20-20	1.11/16"X12	32	20	1.1/4"
TFGSP90-20-24	1.11/16"X12	40	24	1.1/2"

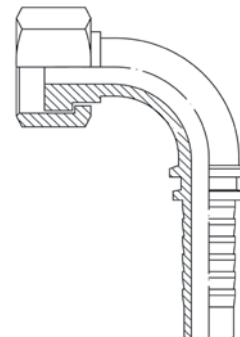

TFGSP90L

FÊMEA GIRATÓRIA CURVA 90° LONGA SEDE PLANA ORFS SAE J1453

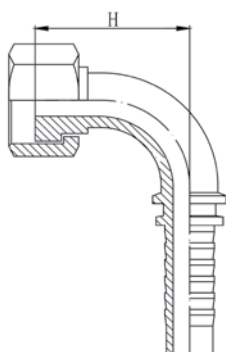

COD. ARAFLEX	ROSCA	DIMENSÃO "H"	MANGUEIRA		
			DN	TRAÇO	POL.
TFGSP90L-04-04	9/16"X18	45,5	06	04	1/4"
TFGSP90L-06-04	11/16"X16	53,5	06	04	1/4"
TFGSP90L-06-06	11/16"X16	53,5	10	06	3/8"
TFGSP90L-06-08	11/16"X16	53,5	12	08	1/2"
TFGSP90L-08-06	13/16"X16	63,5	10	06	3/8"
TFGSP90L-08-08	13/16"X16	64	12	08	1/2"
TFGSP90L-10-10	1"X14	69	16	10	5/8"
TFGSP90L-10-12	1"X14	73	20	12	3/4"
TFGSP90L-12-12	1.3/16"X12	96	20	12	3/4"
TFGSP90L-16-16	1.7/16"X12	113,5	25	16	1"

TFGSPM

FÊMEA GIRATÓRIA RETA SEDE PLANA ORFS MÉTRICA

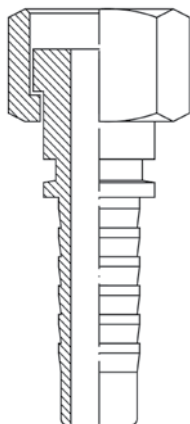

COD. ARAFLEX	ROSCA	MANGUEIRA		
		DN	TRAÇO	POL.
TFGSPM-14-04	M14X1.5	06	04	1/4"
TFGSPM-16-04	M16X1.5	06	04	1/4"
TFGSPM-16-06	M16X1.5	10	06	3/8"
TFGSPM-18-06	M18X1.5	10	06	3/8"
TFGSPM-20-06	M20X1.5	10	06	3/8"
TFGSPM-22-08	M22X1.5	12	08	1/2"
TFGSPM-22-10	M22X1.5	16	10	5/8"
TFGSPM-24-08	M24X1.5	12	08	1/2"
TFGSPM-24-10	M24X1.5	16	10	5/8"
TFGSPM-27-08	M27X1.5	12	08	1/2"
TFGSPM-27-10	M27X1.5	16	10	5/8"
TFGSPM-30-12	M30X1.5	20	12	3/4"
TFGSPM-36-12	M36X2	20	12	3/4"
TFGSPM-42-20	M42X2	32	20	1.1/4"
TFGSPM-45-20	M45X2	32	20	1.1/4"
TFGSPM-52-24	M52X2	40	24	1.1/2"

TFGSPM45

FÊMEA GIRATÓRIA CURVA 45° SEDE PLANA ORFS MÉTRICA

COD. ARAFLEX	ROSCA	MANGUEIRA		
		DN	TRAÇO	POL.
TFGSPM 45-14-04	M14X1.5	06	04	1/4"
TFGSPM45-16-04	M16X1.5	06	04	1/4"
TFGSPM45-16-06	M16X1.5	10	06	3/8"
TFGSPM45-18-06	M18X1.5	10	06	3/8"
TFGSPM45-20-06	M20X1.5	10	06	3/8"
TFGSPM45-22-08	M22X1.5	12	08	1/2"
TFGSPM45-22-10	M22X1.5	16	10	5/8"
TFGSPM45-24-08	M24X1.5	12	08	1/2"
TFGSPM45-24-10	M24X1.5	16	10	5/8"
TFGSPM45-27-08	M27X1.5	12	08	1/2"
TFGSPM45-27-10	M27X1.5	16	10	5/8"
TFGSPM45-30-12	M30X1.5	20	12	3/4"
TFGSPM45-36-12	M36X2	20	12	3/4"
TFGSPM45-42-20	M42X2	32	20	1.1/4"
TFGSPM45-45-20	M45X2	32	20	1.1/4"
TFGSPM45-52-24	M52X2	40	24	1.1/2"

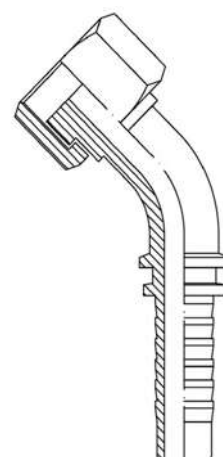

TFGSPM90

FÊMEA GIRATÓRIA CURVA 90° SEDE PLANA ORFS MÉTRICA

COD. ARAFLEX	ROSCA	MANGUEIRA		
		DN	TRAÇO	POL.
TSFSPM90-14-04	M14X1.5	06	04	1/4"
TSFSPM90-16-04	M16X1.5	06	04	1/4"
TSFSPM90-16-06	M16X1.5	10	06	3/8"
TSFSPM90-18-06	M18X1.5	10	06	3/8"
TSFSPM90-20-06	M20X1.5	10	06	3/8"
TSFSPM90-22-08	M22X1.5	12	08	1/2"
TSFSPM90-22-10	M22X1.5	16	10	5/8"
TSFSPM90-24-08	M24X1.5	12	08	1/2"
TSFSPM90-24-10	M24X1.5	16	10	5/8"
TSFSPM90-27-08	M27X1.5	12	08	1/2"
TSFSPM90-27-10	M27X1.5	16	10	5/8"
TSFSPM90-30-12	M30X1.5	20	12	3/4"
TSFSPM90-36-12	M36X2	20	12	3/4"
TSFSPM90-42-20	M42X2	32	20	1.1/4"
TSFSPM90-45-20	M45X2	32	20	1.1/4"
TSFSPM90-52-24	M52X2	40	24	1.1/2"

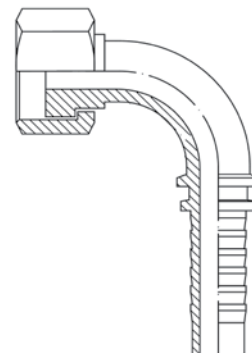

TFGSPB

FÊMEA GIRATÓRIA RETA ROSCA BSP SEDE 60°/JIS B8363

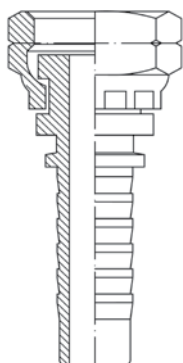

COD. ARAFLEX	ROSCA	MANGUEIRA		
		DN	TRAÇO	POL.
TFGSPB-04-04	1/4"X19	06	04	1/4"
TFGSPB-06-06	3/8"X19	10	06	3/8"
TFGSPB-08-08	1/2"X14	12	08	1/2"
TFGSPB-12-12	3/4"X14	20	12	3/4"
TFGSPB-16-16	1"X11	25	16	1"
TFGSPB-20-20	1.1/4"X11	32	20	1.1/4"
TFGSPB-24-24	1.1/2"X11	40	24	1.1/2"
TFGSPB-32-32	2"X11	50	32	2"

TFGSPB90

FÊMEA GIRATÓRIA CURVA 90° ROSCA BSP SEDE 60°/JIS B8369

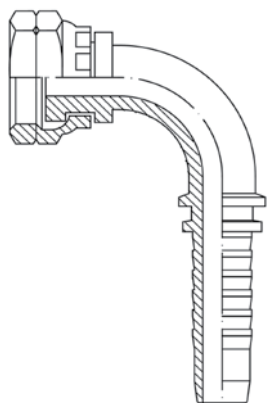

COD. ARAFLEX	ROSCA	MANGUEIRA		
		DN	TRAÇO	POL.
TFGSPB90-08-08	1/2"X14	12	08	1/2"
TFGSPB90-10-10	5/8"X14	16	10	5/8"
TFGSPB90-12-12	3/4"X14	20	12	3/4"
TFGSPB90-16-16	1"X11	25	16	1"
TFGSPB90-20-20	1.1/4"X11	32	20	1.1/4"
TFGSPB90-24-24	1.1/2"X11	40	24	1.1/2"
TFGSPB90-32-32	2"X11	50	32	2"

TMFB

MACHO FIXO BSP SEDE 60°/BS 5200

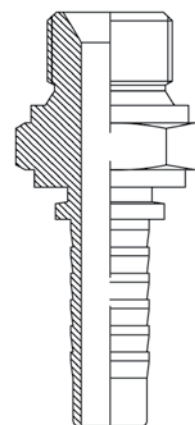

COD. ARAFLEX	ROSCA	MANGUEIRA		
		DN	TRAÇO	POL.
TMFB-02-04	1/8"X28	06	04	1/4"
TMFB-04-04	1/4"X19	06	04	1/4"
TMFB-06-04	3/8"X19	06	04	1/4"
TMFB-06-06	3/8"X19	10	06	3/8"
TMFB-06-08	3/8"X19	12	08	1/2"
TMFB-08-06	1/2"X14	10	06	3/8"
TMFB-08-08	1/2"X14	12	08	1/2"
TMFB-08-10	1/2"X14	16	10	5/8"
TMFB-10-08	5/8"X14	12	08	1/2"
TMFB-10-10	5/8"X14	16	10	5/8"
TMFB-12-08	3/4"X14	12	08	1/2"
TMFB-12-10	3/4"X14	16	10	5/8"
TMFB-12-12	3/4"X14	20	12	3/4"
TMFB-16-12	1"X11	20	12	3/4"
TMFB-16-16	1"X11	25	16	1"
TMFB-20-16	1.1/4"X11	25	16	1"
TMFB-20-20	1.1/4"X11	32	20	1.1/4"
TMFB-24-24	1.1/2"X11	40	24	1.1/2"
TMFB-32-32	2"X11	50	32	2"

TSFB**FÊMEA GIRATÓRIA BSP SEDE 60°/BS 5200**

COD. ARAFLEX	ROSCA	MANGUEIRA		
		DN	TRAÇO	POL.
TSFB-02-04	1/8"X28	06	04	1/4"
TSFB-04-04	1/4"X19	06	04	1/4"
TSFB-04-06	1/4"X19	10	06	3/8"
TSFB-06-04	3/8"X19	06	04	1/4"
TSFB-06-06	3/8"X19	10	06	3/8"
TSFB-06-08	3/8"X19	12	08	1/2"
TSFB-08-06	1/2"X14	10	06	3/8"
TSFB-08-08	1/2"X14	12	08	1/2"
TSFB-08-10	1/2"X14	16	10	5/8"
TSFB-10-08	5/8"X14	12	08	1/2"
TSFB-10-10	5/8"X14	16	10	5/8"
TSFB-10-12	5/8"X14	20	12	3/4"
TSFB-12-08	3/4"X14	12	08	1/2"
TSFB-12-10	3/4"X14	16	10	5/8"
TSFB-12-12	3/4"X14	20	12	3/4"
TSFB-16-12	1"X11	20	12	3/4"
TSFB-16-16	1"X11	25	16	1"
TSFB-20-16	1.1/4"X11	25	16	1"
TSFB-20-20	1.1/4"X11	32	20	1.1/4"
TSFB-24-20	1.1/2"X11	32	20	1.1/4"
TSFB-24-24	1.1/2"X11	40	24	1.1/2"
TSFB-32-32	2"X11	50	32	2"

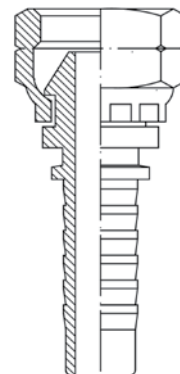

TSFB45

FÊMEA GIRATÓRIA CURVA 45° BSP SEDE 60°/BS 5200

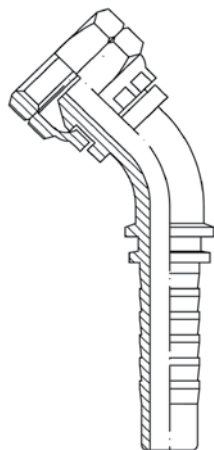

COD. ARAFLEX	ROSCA	MANGUEIRA		
		DN	TRAÇO	POL.
TSFB45-02-04	1/8"X28	06	04	1/4"
TSFB45-04-04	1/4"X19	06	04	1/4"
TSFB45-06-04	3/8"X19	06	04	1/4"
TSFB45-06-06	3/8"X19	10	06	3/8"
TSFB45-08-06	1/2"X14	10	06	3/8"
TSFB45-08-08	1/2"X14	12	08	1/2"
TSFB45-10-08	5/8"X14	12	08	1/2"
TSFB45-10-10	5/8"X14	16	10	5/8"
TSFB45-12-08	3/4"X14	12	08	1/2"
TSFB45-12-10	3/4"X14	16	10	5/8"
TSFB45-12-12	3/4"X14	20	12	3/4"
TSFB45-16-12	1"X11	20	12	3/4"
TSFB45-16-16	1"X11	25	16	1"
TSFB45-20-16	1.1/4"X11	25	16	1"
TSFB45-20-20	1.1/4"X11	32	20	1.1/4"
TSFB45-24-24	1.1/2"X11	40	24	1.1/2"
TSFB45-32-32	2"X11	50	32	2"

TSFB90

FÊMEA GIRATÓRIA CURVA 90° BSP SEDE 60°/BS 5200

COD. ARAFLEX	ROSCA	MANGUEIRA		
		DN	TRAÇO	POL.
TSFB90-02-04	1/8"X28	06	04	1/4"
TSFB90-04-04	1/4"X19	06	04	1/4"
TSFB90-04-06	1/4"X19	10	06	3/8"
TSFB90-06-04	3/8"X19	06	04	1/4"
TSFB90-06-06	3/8"X19	10	06	3/8"
TSFB90-08-06	1/2"X14	10	06	3/8"
TSFB90-08-08	1/2"X14	12	08	1/2"
TSFB90-08-10	1/2"X14	16	10	5/8"
TSFB90-10-08	5/8"X14	12	08	1/2"
TSFB90-10-10	5/8"X14	16	10	5/8"
TSFB90-12-08	3/4"X14	12	08	1/2"
TSFB90-12-10	3/4"X14	16	10	5/8"
TSFB90-12-12	3/4"X14	20	12	3/4"
TSFB90-16-12	1"X11	20	12	3/4"
TSFB90-16-16	1"X11	25	16	1"
TSFB90-20-16	1.1/4"X11	25	16	1"
TSFB90-20-20	1.1/4"X11	32	20	1.1/4"
TSFB90-24-20	1.1/2"X11	32	20	1.1/4"
TSFB90-24-24	1.1/2"X11	40	24	1.1/2"
TSFB90-32-32	2"X11	50	32	2"

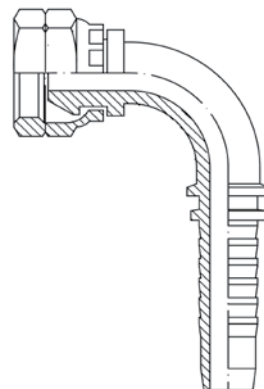

TFGB

FÊMEA GIRATÓRIA RETA MÉTRICA BOLEADA - SEDE UNIVERSAL

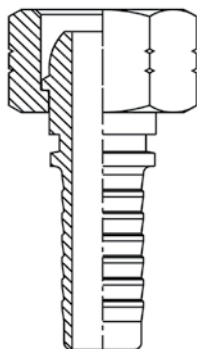

COD. ARAFLEX	ROSCA	MANGUEIRA		
		DN	TRAÇO	POL.
TFGB-08-04	M14X1.5	06	04	1/4"
TFGB-10-04	M16X1.5	06	04	1/4"
TFGB-10-06	M16X1.5	10	06	3/8"
TFGB-12-06	M18X1.5	10	06	3/8"
TFGB-15-06	M22X1.5	10	06	3/8"
TFGB-15-08	M22X1.5	12	08	1/2"
TFGB-18-10	M26X1.5	16	10	5/8"

TFGB45

FÊMEA GIRATÓRIA CURVA 45° MÉTRICA BOLEADA - SEDE UNIVERSAL

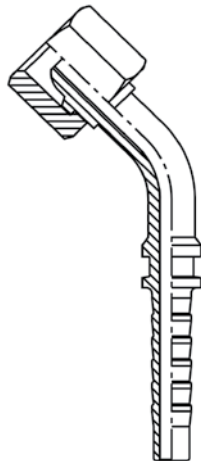

COD. ARAFLEX	ROSCA	MANGUEIRA		
		DN	TRAÇO	POL.
TFGB45-08-04	M14X1.5	06	04	1/4"
TFGB45-10-04	M16X1.5	06	04	1/4"
TFGB45-10-06	M16X1.5	10	06	3/8"
TFGB45-12-06	M18X1.5	10	06	3/8"
TFGB45-15-06	M22X1.5	10	06	3/8"
TFGB45-15-08	M22X1.5	12	08	1/2"
TFGB45-18-10	M26X1.5	16	10	5/8"

TFGB90

FÊMEA GIRATÓRIA CURVA 90° MÉTRICA BOLEADA - SEDE UNIVERSAL

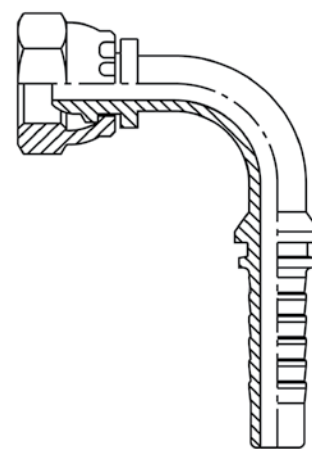

COD. ARAFLEX	ROSCA	MANGUEIRA		
		DN	TRAÇO	POL.
TFGB90-08-04	M14X1.5	06	04	1/4"
TFGB90-10-04	M16X1.5	06	04	1/4"
TFGB90-10-06	M16X1.5	10	06	3/8"
TFGB90-12-06	M18X1.5	10	06	3/8"
TFGB90-15-06	M22X1.5	10	06	3/8"
TFGB90-15-08	M22X1.5	12	08	1/2"
TFGB90-18-10	M26X1.5	16	10	5/8"

TFGJB

FÊMEA GIRATÓRIA RETA BSP/JIC CÔNICO 30°

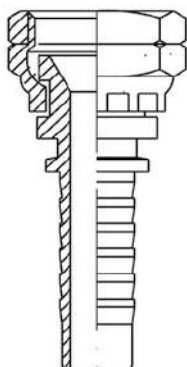

COD. ARAFLEX	ROSCA	MANGUEIRA		
		DN	TRAÇO	POL.
TFGJB-04-04	1/4"X19	06	04	1/4"
TFGJB-06-06	3/8"X19	10	06	3/8"
TFGJB-08-08	1/2"X14	12	08	1/2"
TFGJB-12-12	3/4"X14	20	12	3/4"
TFGJB-16-16	1"X11	25	16	1"

TFGCB90

FÊMEA GIRATÓRIA COMPACTA BSP CÔNICO 60°

COD. ARAFLEX	ROSCA	MANGUEIRA		
		DN	TRAÇO	POL.
TFGCB90-04-04	1/4"X19	06	04	1/4"
TFGCB90-06-06	3/8"X19	10	06	3/8"
TFGCB90-08-08	1/2"X14	12	08	1/2"
TFGCB90-10-10	5/8"X14	16	10	5/8"
TFGCB90-12-12	3/4"X14	20	12	3/4"
TFGCB90-16-16	1"X11	25	16	1"

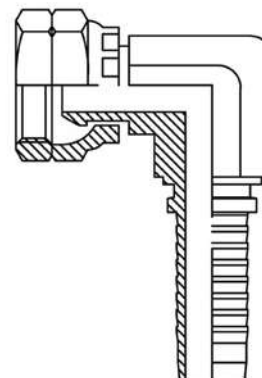

TFR3

FLANGE RETA CÓD. 61 3000 PSI SAE J518

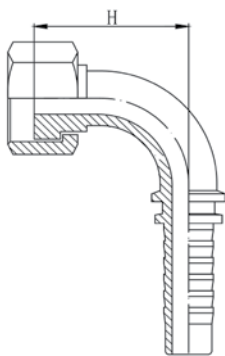

COD. ARAFLEX	FLANGE	DIMENSÃO "C"	MANGUEIRA		
			DN	TRAÇO	POL.
TFR3-08-08	1/2"	30.2	12	08	1/2"
TFR3-10-08	5/8"	34.2	12	08	1/2"
TFR3-10-10	5/8"	34.2	16	10	5/8"
TFR3-12-08	3/4"	38.1	12	08	1/2"
TFR3-12-10	3/4"	38.1	16	10	5/8"
TFR3-12-12	3/4"	38.1	20	12	3/4"
TFR3-12-16	3/4"	38.1	25	16	1"
TFR3-16-12	1"	44.4	20	12	3/4"
TFR3-16-16	1"	44.4	25	16	1"
TFR3-16-20	1"	44.4	32	20	1.1/4"
TFR3-20-16	1.1/4"	50.8	25	16	1"
TFR3-20-20	1.1/4"	50.8	32	20	1.1/4"
TFR3-24-16	1.1/2"	60.3	25	16	1"
TFR3-24-20	1.1/2"	60.3	32	20	1.1/4"
TFR3-24-24	1.1/2"	60.3	40	24	1.1/2"
TFR3-32-24	2"	71.4	40	24	1.1/2"
TFR3-32-32	2"	71.4	50	32	2"

TFR345

FLANGE CURVA 45° CÓD. 61 3000 PSI SAE J518

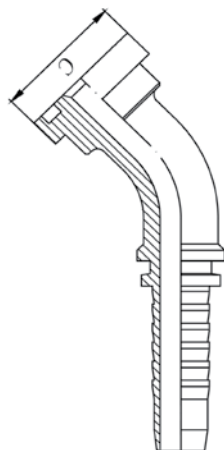

COD. ARAFLEX	FLANGE	DIMENSÃO "C"	MANGUEIRA		
			DN	TRAÇO	POL.
TFR345-08-08	1/2"	30,2	12	08	1/2"
TFR345-10-08	5/8"	34,2	12	08	1/2"
TFR345-10-10	5/8"	34,2	16	10	5/8"
TFR345-12-08	3/4"	38,1	12	08	1/2"
TFR345-12-10	3/4"	38,1	16	10	5/8"
TFR345-12-12	3/4"	38,1	20	12	3/4"
TFR345-16-12	1"	38,1	20	12	3/4"
TFR345-16-16	1"	44,4	25	16	1"
TFR345-16-20	1"	44,4	32	20	1.1/4"
TFR345-20-16	1.1/4"	50,8	25	16	1"
TFR345-20-20	1.1/4"	50,8	32	20	1.1/4"
TFR345-24-16	1.1/2"	60,3	25	16	1"
TFR345-24-20	1.1/2"	60,3	32	20	1.1/4"
TFR345-24-24	1.1/2"	60,3	40	24	1.1/4"
TFR345-32-24	2"	71,4	40	24	1.1/2"
TFR345-32-32	2"	71,4	50	32	2"

TFR390

FLANGE CURVA 90° CÓD. 61 3000 PSI SAE J518

COD. ARAFLEX	FLANGE	DIMENSÃO "C"	MANGUEIRA		
			DN	TRAÇO	POL.
TFR390-08-08	1/2"	30,2	12	08	1/2"
TFR390-10-08	5/8"	34,2	12	08	1/2"
TFR390-10-10	5/8"	34,2	16	10	5/8"
TFR390-12-08	3/4"	38,1	12	08	1/2"
TFR390-12-10	3/4"	38,1	16	10	5/8"
TFR390-12-12	3/4"	38,1	20	12	3/4"
TFR390-16-12	1"	44,4	20	12	3/4"
TFR390-16-16	1"	44,4	25	16	1"
TFR390-16-20	1"	44,4	32	20	1.1/4"
TFR390-20-12	1.1/4"	50,8	20	12	3/4"
TFR390-20-16	1.1/4"	50,8	25	16	1"
TFR390-20-20	1.1/4"	50,8	32	20	1.1/4"
TFR390-24-16	1.1/2"	60,3	25	16	1"
TFR390-24-20	1.1/2"	60,3	32	20	1.1/4"
TFR390-24-24	1.1/2"	60,3	40	24	1.1/4"
TFR390-24-32	1.1/2"	60,3	50	32	2"
TFR390-32-24	1.1/2"	71,4	40	24	1.1/4"
TFR390-32-32	2"	71,4	50	32	2"

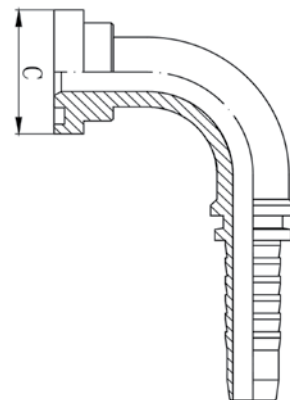

TFR390L

FLANGE CURVA 90° LONGA CÓD. 61 3000 PSI SAE J518

COD. ARAFLEX	FLANGE	DIMENSÃO "H"	MANGUEIRA		
			DN	TRAÇO	POL.
TFR390L-12-12	3/4"	96	20	12	3/4"
TFR390L-16-12	1"	96	20	12	3/4"
TFR390L-16-16	1"	96	25	16	1"
TFR390L-20-16	1.1/4"	117	25	16	1"
TFR390L-20-20	1.1/4"	96	32	20	1.1/4"
TFR390L-24-20	1.1/2"	130	32	20	1.1/4"

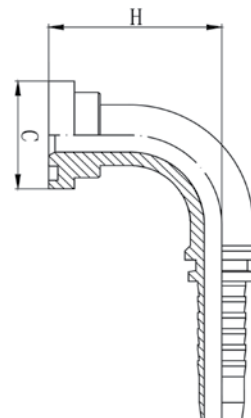

TFR6

FLANGE RETA CÓD. 62 6000 PSI SAE J518

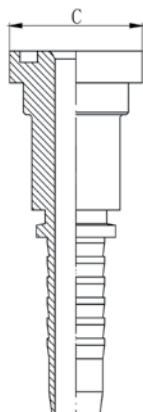

COD. ARAFLEX	FLANGE	DIMENSÃO "C"	MANGUEIRA		
			DN	TRAÇO	POL.
TFR6-08-08	1/2"	31.7	12	08	1/2"
TFR6-08-10	1/2"	31.7	16	10	5/8"
TFR6-12-08	3/4"	41.3	12	08	1/2"
TFR6-12-10	3/4"	41.3	16	10	5/8"
TFR6-12-12	3/4"	41.3	20	12	3/4"
TFR6-16-12	1"	47.6	20	12	3/4"
TFR6-16-16	1"	47.6	25	16	1"
TFR6-20-16	1.1/4"	54	25	16	1"
TFR6-20-20	1.1/4"	54	32	20	1.1/4"
TFR6-24-20	1.1/2"	63.5	32	20	1.1/4"
TFR6-24-24	1.1/2"	63.5	40	24	1.1/2"
TFR6-32-32	2"	79.4	50	32	2"

TFR645

FLANGE CURVA 45° CÓD. 62 6000 PSI SAE J518

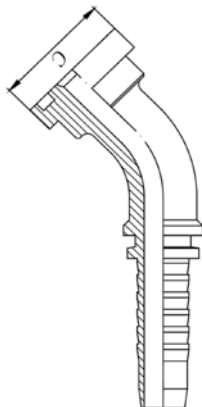

COD. ARAFLEX	FLANGE	DIMENSÃO "C"	MANGUEIRA		
			DN	TRAÇO	POL.
TFR645-08-08	1/2"	31.7	12	08	1/2"
TFR645-12-08	3/4"	41.3	12	08	1/2"
TFR645-12-10	3/4"	41.3	16	10	5/8"
TFR645-12-12	3/4"	41.3	20	12	3/4"
TFR645-16-12	1"	47.6	20	12	3/4"
TFR645-16-16	1"	47.6	25	16	1"
TFR645-16-20	1"	47.6	32	20	1.1/4"
TFR645-20-16	1.1/4"	54	25	16	1"
TFR645-20-20	1.1/4"	54	32	20	1.1/4"
TFR645-24-20	1.1/2"	63.5	32	20	1.1/4"
TFR645-24-24	1.1/2"	63.5	40	24	1.1/2"
TFR645-32-32	2"	79.4	50	32	2"

TFR690

FLANGE CURVA 90° CÓD. 62 6000 PSI SAE J518

COD. ARAFLEX	FLANGE	DIMENSÃO "C"	MANGUEIRA		
			DN	TRAÇO	POL.
TFR690-08-08	1/2"	31.7	12	08	1/2"
TFR690-12-08	3/4"	41.3	12	08	1/2"
TFR690-12-10	3/4"	41.3	16	10	5/8"
TFR690-12-12	3/4"	41.3	20	12	3/4"
TFR690-16-12	1"	47.6	20	12	3/4"
TFR690-16-16	1"	47.6	25	16	1"
TFR690-16-20	1"	47.6	32	20	1.1/4"
TFR690-20-16	1.1/4"	54	25	16	1"
TFR690-20-20	1.1/4"	54	32	20	1.1/4"
TFR690-24-20	1.1/2"	63.5	32	20	1.1/4"
TFR690-24-24	1.1/2"	63.5	40	24	1.1/2"
TFR690-32-32	2"	79.4	50	32	2"

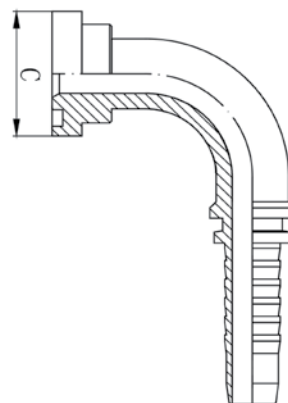

TFR690L

FLANGE CURVA 90° LONGA CÓD. 62 6000 PSI SAE J518

COD. ARAFLEX	FLANGE	DIMENSÃO "H"	MANGUEIRA		
			DN	TRAÇO	POL.
TFR690L-12-12	3/4"	114	20	12	3/4"
TFR690L-16-12	1"	96	20	12	3/4"
TFR690L-16-16	1"	114	25	16	1"
TFR690L-20-16	1.1/4"	117	25	16	1"
TFR690L-20-20	1.1/4"	114	32	20	1.1/4"
TFR690L-24-20	1.1/2"	130	32	20	1.1/4"

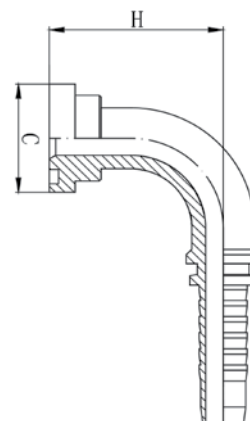

TFR9

FLANGE RETA CAT (9000 PSI)

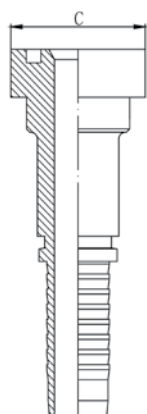

COD. ARAFLEX	FLANGE	DIMENSÃO "C"	MANGUEIRA		
			DN	TRAÇO	POL.
TFR9-12-12	3/4"	41.3	20	12	3/4"
TFR9-16-12	1"	47.6	20	12	3/4"
TFR9-16-16	1"	47.6	25	16	1"
TFR9-20-16	1.1/4"	54	25	16	1"
TFR9-20-20	1.1/4"	54	32	20	1.1/4"
TFR9-24-24	1.1/2"	63.5	40	24	1.1/2"
TFR9-32-32	2"	79.4	50	32	2"

TFR945

FLANGE CURVA 45° CAT (9000 PSI)

COD. ARAFLEX	FLANGE	DIMENSÃO "C"	MANGUEIRA		
			DN	TRAÇO	POL.
TFR945-12-12	3/4"	41.3	20	12	3/4"
TFR945-16-12	1"	47.6	20	12	3/4"
TFR945-16-16	1"	47.6	25	16	1"
TFR945-20-16	1.1/4"	54	25	16	1"
TFR945-20-20	1.1/4"	54	32	20	1.1/4"
TFR945-24-24	1.1/2"	63.5	40	24	1.1/2"
TFR945-32-32	2"	79.4	50	32	2"

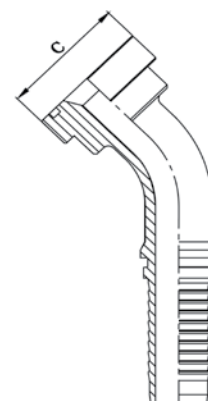

TFR990

FLANGE CURVA 90° CAT (9000 PSI)

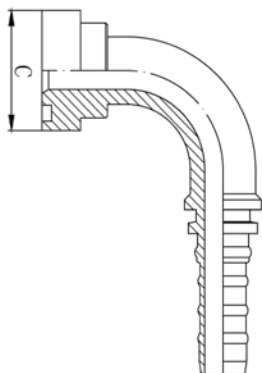

COD. ARAFLEX	FLANGE	DIMENSÃO "C"	MANGUEIRA		
			DN	TRAÇO	POL.
TFR990-12-12	3/4"	41.3	20	12	3/4"
TFR990-16-12	1"	47.6	20	12	3/4"
TFR990-16-16	1"	47.6	25	16	1"
TFR990-20-16	1.1/4"	54	25	16	1"
TFR990-20-20	1.1/4"	54	32	20	1.1/4"
TFR990-24-24	1.1/2"	63.5	40	24	1.1/2"
TFR990-32-32	2"	79.4	50	32	2"

TPL
PONTA LISA RETA

COD. ARAFLEX	DN TUBO	MANGUEIRA		
		DN	TRAÇO	POL.
TPL-06-04	6	06	04	1/4"
TPL-08-04	8	06	04	1/4"
TPL-10-04	10	06	04	1/4"
TPL-10-06	10	06	04	1/4"
TPL-12-04	12	06	04	1/4"
TPL-12-06	12	10	06	3/8"
TPL-12-08	12	12	08	1/2"
TPL-14-06	14	10	06	3/8"
TPL-14-08	14	12	08	1/2"
TPL-15-06	15	10	06	3/8"
TPL-15-08	15	12	08	1/2"
TPL-16-08	16	12	08	1/2"
TPL-16-10	16	16	10	5/8"
TPL-18-08	18	12	08	1/2"
TPL-18-10	18	16	10	5/8"
TPL-18-12	18	20	12	3/4"
TPL-19-10	19	16	10	5/8"
TPL-20-10	20	16	10	5/8"
TPL-20-12	20	20	12	3/4"
TPL-22-10	22	16	10	5/8"
TPL-22-12	22	20	12	3/4"
TPL-25-12	25	20	12	3/4"
TPL-25-16	25	25	16	1"
TPL-28-16	28	25	16	1"
TPL-30-16	30	25	16	1"
TPL-30-20	30	32	20	1.1/4"
TPL-35-20	35	32	20	1.1/4"
TPL-38-16	38	25	16	1"
TPL-38-20	38	32	20	1.1/4"
TPL-38-24	38	40	24	1.1/2"
TPL-42-20	42	32	20	1.1/4"
TPL-42-24	42	40	24	1.1/2"

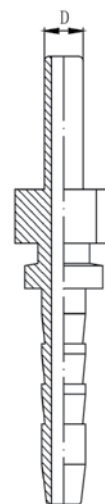

TPL90

PONTA LISA CURVA 90°

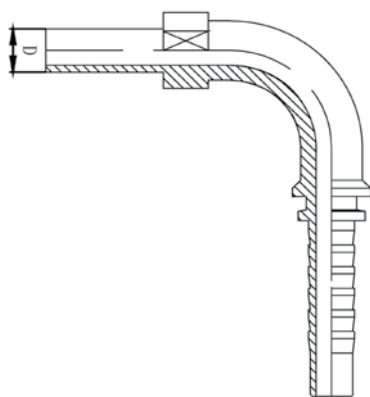

COD. ARAFLEX	DN TUBO	MANGUEIRA		
		DN	TRAÇO	POL.
TPL90-06-04	6	06	04	1/4"
TPL90-08-04	8	06	04	1/4"
TPL90-10-04	10	06	04	1/4"
TPL90-10-06	10	06	04	1/4"
TPL90-12-04	12	06	04	1/4"
TPL90-12-06	12	10	06	3/8"
TPL90-12-08	12	12	08	1/2"
TPL90-14-06	14	10	06	3/8"
TPL90-14-08	14	12	08	1/2"
TPL90-15-08	15	12	08	1/2"
TPL90-16-08	16	12	08	1/2"
TPL90-16-12	16	10	12	3/4"
TPL90-18-08	18	12	08	1/2"
TPL90-18-10	18	16	10	5/8"
TPL90-18-12	18	16	10	5/8"
TPL90-19-10	19	16	10	5/8"
TPL90-20-10	20	16	10	5/8"
TPL90-20-12	20	20	12	3/4"
TPL90-22-10	22	16	10	5/8"
TPL90-22-12	22	20	12	3/4"
TPL90-25-12	25	20	12	3/4"
TPL90-25-16	25	25	16	1"
TPL90-28-16	28	25	16	1"
TPL90-30-16	30	25	16	1"
TPL90-35-20	35	32	20	1.1/4"

EMH

EMENDA HIDRÁULICA

COD. ARAFLEX	DIMENSÃO "L"	MANGUEIRA		
		DN	TRAÇO	POL.
EMH-04	74	06	04	1/4"
EMH-05	76	08	05	5/16"
EMH-06	78	10	06	3/8"
EMH-08	86	12	08	1/2"
EMH-10	90	16	10	5/8"
EMH-12	99	20	12	3/4"
EMH-16	121	25	16	1"
EMH-20	130	32	20	1.1/4"
EMH-24	136	40	24	1.1/2"
EMH-32	177	50	32	2"

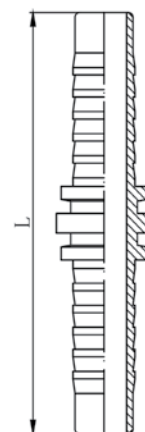

TOLM

OLHAL RETO - MÉTRICO

COD. ARAFLEX	ROSCA	MANGUEIRA		
		DN	TRAÇO	POL.
TOLM-10-04	M10	06	04	1/4"
TOLM-12-04	M12	06	04	1/4"
TOLM-12-06	M12	10	06	3/8"
TOLM-14-04	M14	06	04	1/4"
TOLM-14-06	M14	10	06	3/8"
TOLM-16-06	M16	10	06	3/8"
TOLM-16-08	M16	12	08	1/2"
TOLM-18-06	M18	10	06	3/8"
TOLM-18-08	M18	10	06	3/8"
TOLM-19-06	M19	12	08	1/2"
TOLM-21-06	M21	10	06	3/8"
TOLM-22-08	M22	12	08	1/2"
TOLM-22-10	M22	16	10	5/8"
TOLM-26-10	M26	16	10	5/8"
TOLM-26-12	M26	20	12	3/4"

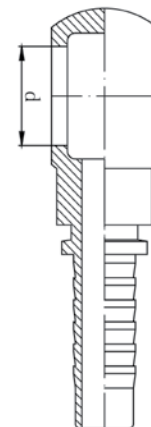

TOLB

OLHAL RETO - BSP

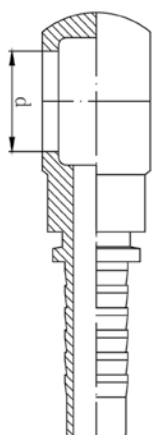

COD. ARAFLEX	ROSCA	MANGUEIRA		
		DN	TRAÇO	POL.
TOLB-04-04	1/4"-19	06	04	1/4"
TOLB-06-06	3/8"-19	10	06	3/8"
TOLB-08-06	1/2"-14	10	06	3/8"
TOLB-08-08	1/2"-14	12	08	1/2"
TOLB-10-10	5/8"-14	16	10	5/8"
TOLB-12-12	3/4"-14	20	12	3/4"
TOLB-16-16	1"-11	25	16	1"

TSV

PINO SALVA VIDAS

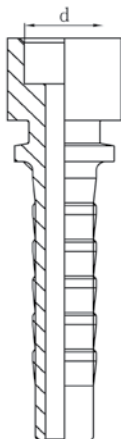

COD. ARAFLEX	D	MANGUEIRA		
		DN	TRAÇO	POL.
TSV-06-04	06	06	04	1/4"
TSV-08-04	08	06	04	1/4"
TSV-12-06	12	10	06	3/8"
TSV-14-06	14	10	06	3/8"
TSV-15-08	15	12	08	1/2"
TSV-16-08	16	12	08	1/2"
TSV-18-10	18	16	10	5/8"
TSV-22-12	22	20	12	3/4"
TSV-28-16	28	25	16	1"
TSV-35-20	35	32	20	1.1/4"
TSV-40-24	40	40	24	1.1/2"
TSV-50-32	50	50	32	2"

TWASH

FÊMEA GIRATÓRIA KARCHER

COD. ARAFLEX	DIMENSÃO "L"	MANGUEIRA		
		DN	TRAÇO	POL.
TWASH-22-04	M22X1.5	06	04	1/4"
TWASH-22-05	M22X1.5	08	05	5/16"
TWASH-22-06	M22X1.5	10	06	3/8"

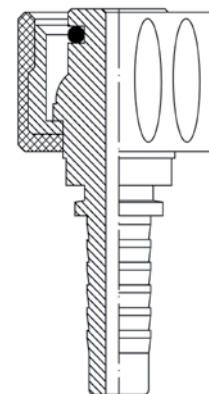

TPMK

PINO MINI KARCHER

COD. ARAFLEX	D	MANGUEIRA	
		TRAÇO	POL.
TPMK-10-04	10	04	1/4"
TPMK-14-04	14	04	1/4"
TPMK-15-04	15	04	1/4"



Terminais **Interlok**

CIT

CAPA Prensada Interlock para Mangueira 4SH/ R13 (Skive)

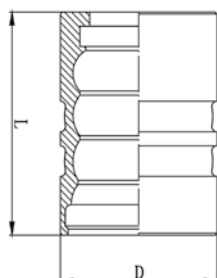

COD. ARAFLEX
MANGUEIRA

	DN	TRAÇO	POL.
CIT-10	10	06	3/8"
CIT-12	20	12	3/4"
CIT-16	25	16	1"
CIT-20	32	20	1.1/4"
CIT-24	40	24	1.1/2"
CIT-32	50	32	2"

TIF3

FLANGE RETA Cód. 61 3000 PSI - INTERLOCK SAE J518

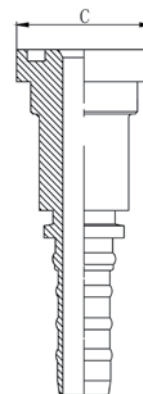
COD. ARAFLEX	FLANGE	DIMENSÃO "C"	MANGUEIRA		
			DN	TRAÇO	POL.
TIF3-12-12	3/4"	38.1	20	12	3/4"
TIF3-12-16	3/4"	38.1	25	16	1"
TIF3-16-12	1"	44.4	20	12	3/4"
TIF3-16-16	1"	44.4	25	16	1"
TIF3-20-16	1.1/4"	50.8	25	16	1"
TIF3-20-20	1.1/4"	50.8	32	20	1.1/4"
TIF3-24-20	1.1/2"	60.3	32	20	1.1/4"
TIF3-24-24	1.1/2"	60.3	40	24	1.1/2"
TIF3-32-24	2"	71.4	40	24	1.1/2"
TIF3-32-32	2"	71.4	50	32	2"



TIF345

FLANGE CURVA 45° Cód. 61 3000 PSI - INTERLOCK SAE J518

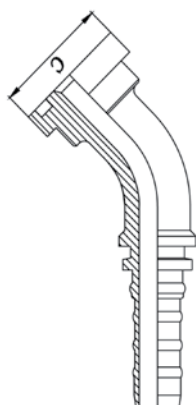

COD. ARAFLEX	FLANGE	DIMENSÃO "C"	MANGUEIRA		
			DN	TRAÇO	POL.
TIF345-12-12	3/4"	38.1	20	12	3/4"
TIF345-16-12	3/4"	38.1	20	12	3/4"
TIF345-16-16	1"	44.4	25	16	1"
TIF345-20-16	1"	44.4	25	16	1"
TIF345-20-20	1.1/4"	50.8	32	20	1.1/4"
TIF345-24-20	1.1/4"	50.8	32	20	1.1/4"
TIF345-24-24	1.1/2"	60.3	40	24	1.1/2"
TIF345-32-24	1.1/2"	60.3	40	24	1.1/2"
TIF345-32-32	2"	71.4	50	32	2"

TIF390

FLANGE CURVA 90° CÓD. 61
3000 PSI - INTERLOCK SAE J518

COD. ARAFLEX	FLANGE	DIMENSÃO "C"	MANGUEIRA		
			DN	TRAÇO	POL.
TIF390-12-12	3/4"	38.1	20	12	3/4"
TIF390-16-12	1"	44.4	20	12	3/4"
TIF390-16-16	1"	44.4	25	16	1"
TIF390-16-20	1"	44.4	32	20	1"
TIF390-20-16	1.1/4"	50.8	25	16	1"
TIF390-20-20	1.1/4"	50.8	32	20	1.1/4"
TIF390-20-20	1.1/2"	50.8	32	20	1.1/4"
TIF390-24-24	2"	60.3	40	24	1.1/2"
TIF390-32-24	2"	71.4	40	24	1.1/2"
TIF390-32-32	2"	71.4	50	32	2"

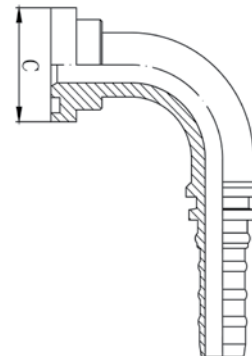

TIF6

FLANGE RETA CÓD. 62
6000 PSI - INTERLOCK SAE J518

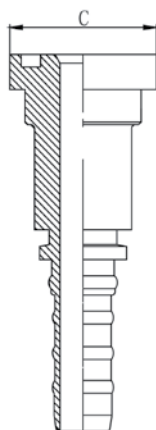

COD. ARAFLEX	FLANGE	DIMENSÃO "C"	MANGUEIRA		
			DN	TRAÇO	POL.
TIF6-12-10	3/4"	41.3	16	10	5/8"
TIF6-12-12	3/4"	41.3	20	12	3/4"
TIF6-12-16	3/4"	41.3	25	16	1"
TIF6-16-10	1"	47.6	16	10	5/8"
TIF6-16-12	1"	47.6	20	12	3/4"
TIF6-16-16	1"	47.6	25	16	1"
TIF6-16-20	1"	47.6	32	20	1.1/4"
TIF6-20-16	1.1/4"	54	25	16	1"
TIF6-20-20	1.1/4"	54	32	20	1.1/4"
TIF6-20-24	1.1/4"	54	40	24	1.1/2"
TIF6-24-20	1.1/2"	63.5	32	20	1.1/4"
TIF6-24-24	1.1/2"	63.5	40	24	1.1/2"
TIF6-24-32	1.1/2"	63.5	50	32	2"
TIF6-32-24	2"	79.4	40	24	1.1/2"
TIF6-32-32	2"	79.4	50	32	2"

TIF645

FLANGE CURVA 45° CÓD. 62
6000 PSI - INTERLOCK SAE J518

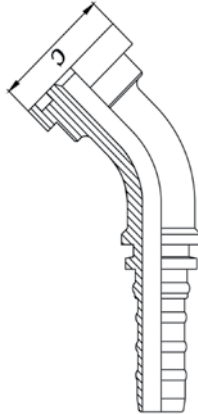

COD. ARAFLEX	FLANGE	DIMENSÃO "C"	MANGUEIRA		
			DN	TRAÇO	POL.
TIF645-12-12	3/4"	41.3	20	12	3/4"
TIF645-16-12	1"	47.6	20	12	3/4"
TIF645-12-10	3/4"	41.3	16	10	5/8"
TIF645-12-16	3/4"	41.3	25	16	1"
TIF645-16-10	1"	47.6	16	10	5/8"
TIF645-16-12	1"	47.6	20	12	3/4"
TIF645-16-16	1"	47.6	25	16	1"
TIF645-16-20	1"	47.6	32	20	1.1/4"
TIF645-20-16	1.1/4"	54	25	16	1"
TIF645-20-20	1.1/4"	54	32	20	1.1/4"
TIF645-24-20	1.1/2"	63.5	32	20	1.1/4"
TIF645-24-20	1.1/2"	63.5	32	20	1.1/4"
TIF645-24-24	1.1/2"	63.5	40	24	1.1/2"
TIF645-32-24	2"	79.4	40	24	1.1/2"
TIF645-32-32	2"	79.4	50	32	2"

TIF690

FLANGE CURVA 90° CÓD. 62
6000 PSI - INTERLOCK SAE J518

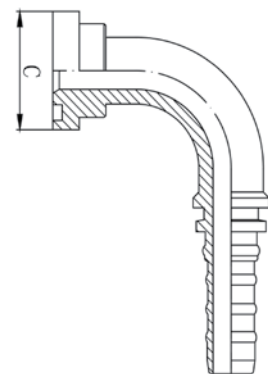

COD. ARAFLEX	FLANGE	DIMENSÃO "C"	MANGUEIRA		
			DN	TRAÇO	POL.
TIF690-12-10	3/4"	41.3	16	10	5/8"
TIF690-12-12	3/4"	41.3	20	12	3/4"
TIF690-12-16	3/4"	41.3	25	16	1"
TIF690-16-10	1"	47.6	16	10	5/8"
TIF690-16-12	1"	47.6	20	12	3/4"
TIF690-16-16	1"	47.6	25	16	1"
TIF690-20-16	1.1/4"	54	25	16	1"
TIF690-20-20	1.1/4"	54	32	20	1.1/4"
TIF690-24-20	1.1/2"	63.5	32	20	1.1/4"
TIF690-24-24	1.1/2"	63.5	40	24	1.1/2"
TIF690-24-24	1.1/2"	63.5	40	24	1.1/2"
TIF690-32-24	2"	79.4	40	24	1.1/2"
TIF690-32-32	2"	79.4	50	32	2"

TIF9

FLANGE RETA SUPERCAT 9000 PSI - INTERLOCK

COD. ARAFLEX	FLANGE	DIMENSÃO "C"	MANGUEIRA		
			DN	TRAÇO	POL.
TIF9-12-12	3/4"	41.3	20	12	3/4"
TIF9-16-12	1"	47.6	20	12	3/4"
TIF9-16-16	1"	47.6	25	16	1"
TIF9-20-16	1.1/4"	54	25	16	1"
TIF9-20-20	1.1/4"	54	32	20	1.1/4"
TIF9-24-20	1.1/2"	63.5	32	20	1.1/4"
TIF9-24-24	1.1/2"	63.5	40	24	1.1/2"
TIF9-24-32	1.1/2"	63.5	50	32	2"
TIF9-32-24	2"	79.4	40	24	1.1/2"
TIF9-32-32	2"	79.4	50	32	2"

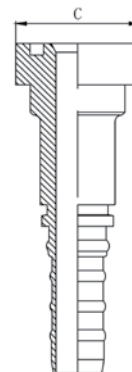

TIF945

FLANGE CURVA 45° SUPERCAT 9000 PSI - INTERLOCK

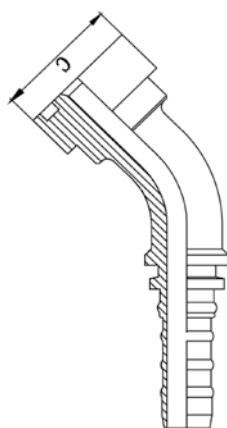

COD. ARAFLEX	FLANGE	DIMENSÃO "C"	MANGUEIRA		
			DN	TRAÇO	POL.
TIF945-12-12	3/4"	41.3	20	12	3/4"
TIF945-16-12	1"	47.6	20	12	3/4"
TIF945-16-16	1"	47.6	25	16	1"
TIF945-20-16	1.1/4"	54	25	16	1"
TIF945-20-20	1.1/4"	54	32	20	1.1/4"
TIF945-24-20	1.1/2"	63.5	32	20	1.1/4"
TIF945-24-24	1.1/2"	63.5	40	24	1.1/2"
TIF945-32-24	2"	79.4	40	24	1.1/2"
TIF945-32-32	2"	79.4	50	32	2"

TIF990

FLANGE CURVA 90° SUPERCAT 9000 PSI - INTERLOCK

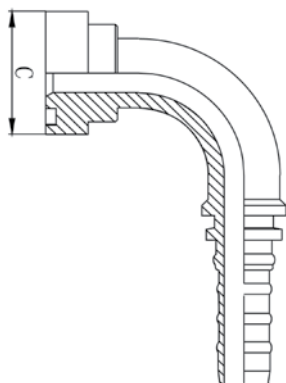

COD. ARAFLEX	FLANGE	DIMENSÃO "C"	MANGUEIRA		
			DN	TRAÇO	POL.
TIF990-12-12	3/4"	41.3	20	12	3/4"
TIF990-16-12	1"	47.6	20	12	3/4"
TIF990-16-16	1"	47.6	25	16	1"
TIF990-20-16	1.1/4"	54	25	16	1"
TIF990-20-20	1.1/4"	54	32	20	1.1/4"
TIF990-24-20	1.1/2"	63.5	32	20	1.1/4"
TIF990-24-24	1.1/2"	63.5	40	24	1.1/2"
TIF990-32-24	2"	79.4	40	24	1.1/2"
TIF990-32-32	2"	79.4	50	32	2"

TIF990L

FLANGE CURVA 90° LONGA SUPERCAT 9000 PSI - INTERLOC

COD. ARAFLEX	FLANGE	DIMENSÃO "H"	MANGUEIRA		
			DN	TRAÇO	POL.
TIF990-16-16	1"/47.6	114	25	16	1"

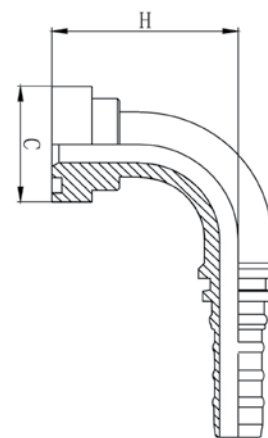

TIFGJ

FÊMEA GIRATÓRIA RETA UNF JIC 37° - INTERLOCK SAE J514

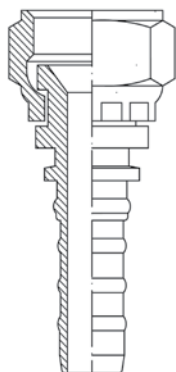

COD. ARAFLEX	ROSCA	MANGUEIRA		
		DN	TRAÇO	POL.
TIFGJ-12-12	1.1/16"X12	20	12	3/4"
TIFGJ-16-12	1.5/16"X12	20	12	3/4"
TIFGJ-16-16	1.5/16"X12	25	16	1"
TIFGJ-20-16	1.5/8"X12	25	16	1"
TIFGJ-20-20	1.5/8"X12	32	20	1.1/4"
TIFGJ-24-24	1.7/8"X12	40	24	1.1/2"
TIFGJ-32-32	2.1/2"X12	50	32	2"

TIFGJ45

**FÊMEA GIRATÓRIA CURVA 45°
UNF JIC 37° - INTERLOCK SAE J514**

COD. ARAFLEX	ROSCA	MANGUEIRA		
		DN	TRAÇO	POL.
TIFGJ45-12-12	1.1/16"X12	20	12	3/4"
TIFGJ45-16-12	1.5/16"X12	20	12	3/4"
TIFGJ45-16-16	1.5/16"X12	25	16	1"
TIFGJ45-20-16	1.5/8"X12	25	16	1"
TIFGJ45-20-20	1.5/8"X12	32	20	1.1/4"
TIFGJ45-24-24	1.7/8"X12	40	24	1.1/2"
TIFGJ45-32-32	2.1/2"X12	50	32	2"

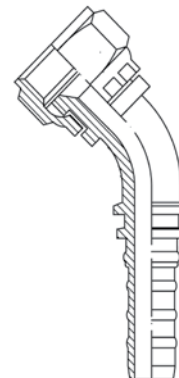
**TIFGJ90**

FÊMEA GIRATÓRIA CURVA 90° JIC 37° INTERLOCK

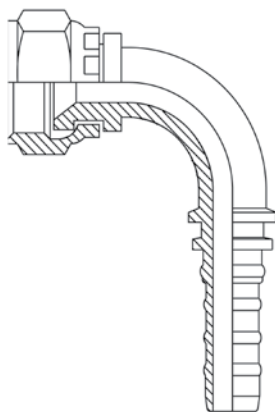

COD. ARAFLEX	ROSCA	MANGUEIRA		
		DN	TRAÇO	POL.
TIFGJ90-12-12	1.1/16"X12	20	12	3/4"
TIFGJ90-16-12	1.5/16"X12	20	12	3/4"
TIFGJ90-16-16	1.5/16"X12	25	16	1"
TIFGJ90-20-16	1.5/8"X12	25	16	1"
TIFGJ90-20-20	1.5/8"X12	32	20	1.1/4"
TIFGJ90-24-20	1.7/8"X12	32	20	1.1/4"
TIFGJ90-24-24	1.7/8"X12	40	24	1.1/2"
TIFGJ90-32-32	2.1/2"X12	50	32	2"

TIMFP

MACHO FIXO NPT - INTERLOCK SEDE 60°/SAE J516

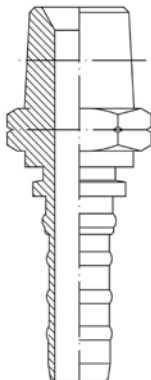

COD. ARAFLEX	ROSCA	MANGUEIRA		
		DN	TRAÇO	POL.
TIMFP-12-12	3/4"X14	20	12	3/4"
TIMFP-16-16	1"X11.5	25	16	1"
TIMFP-20-20	1.1/4"X11.5	32	20	1.1/4"
TIMFP-24-24	1.1/2"X11.5	40	24	1.1/2"
TIMFP-32-32	2"X11.5	50	32	2"

TIFGSP

FÊMEA GIRATÓRIA RETA SEDE PLANA (ORFS) - INTERLOCK SAE J1453

COD. ARAFLEX	ROSCA	MANGUEIRA		
		DN	TRAÇO	POL.
TIFGSP-10-10	1"X14	16	10	5/8"
TIFGSP-12-12	1.3/16"X12	20	12	3/4"
TIFGSP-12-16	1.3/16"X12	25	16	1"
TIFGSP-16-12	1.7/16"X12	20	12	3/4"
TIFGSP-16-16	1.7/16"X12	25	16	1"
TIFGSP-20-16	1.11/16"X12	25	16	1"
TIFGSP-20-16	1.11/16"X12	25	16	1"
TIFGSP-24-24	2"X12	40	24	1.1/2"

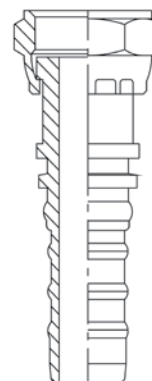

TIFGSP45

FÊMEA GIRATÓRIA CURVA 45° SEDE PLANA (ORFS) - INTERLOCK SAE J1453

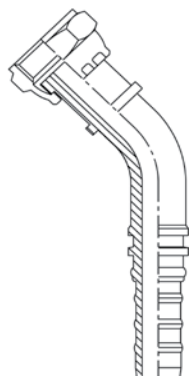

COD. ARAFLEX	ROSCA	MANGUEIRA		
		DN	TRAÇO	POL.
TIFGSP45-12-12	1.3/16"X12	20	12	3/4"
TIFGSP45-16-16	1.7/16"X12	25	16	1"
TIFGSP45-20-20	1.11/16"X12	32	20	1.1/4"
TIFGSP45-24-24	2"X12	40	24	1.1/2"

TIFGSP90

FÊMEA GIRATÓRIA CURVA 90° SEDE PLANA (ORFS) - INTERLOCK SAE J1453

COD. ARAFLEX	ROSCA	MANGUEIRA		
		DN	TRAÇO	POL.
TIFGSP90-12-12	1.3/16"X12	20	12	3/4"
TIFGSP90-16-16	1.7/16"X12	25	16	1"
TIFGSP90-20-16	1.11/16"X12	25	16	1"
TIFGSP90-20-20	1.11/16"X12	32	20	1.1/4"
TIFGSP90-24-24	2"X12	40	24	1.1/2"

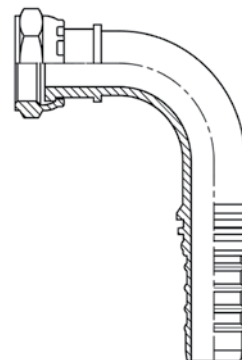

TIMFM

MACHO MÉTRICO PARA TUBO - INTERLOCK SEDE 24°/DIN 3853 - 3861

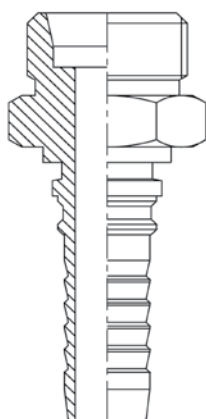

COD.ARAFLEX	ROSCA	DN TUBO	MANGUEIRA		
			DN	TRAÇO	POL.
TIMFM-30-20-10	M30X2.0	20	16	10	5/8"
TIMFM-30-20-12	M30X2.0	20	20	12	3/4"
TIMFM-36-25-12	M36X2.0	25	20	12	3/4"
TIMFM-36-25-16	M36X2.0	25	25	16	1"
TIMFM-42-30-16	M42X2.0	30	25	16	1"
TIMFM-52-38-20	M52X2.0	38	32	20	1.1/4"
TIMFM-52-38-24	M52X2.0	38	40	24	1.1/2"

TIDKO

FÊMEA GIRATÓRIA RETA MÉTRICA DKO - INTERLOCK SEDE 24°/DIN 3865

COD. ARAFLEX	ROSCA	DN TUBO	MANGUEIRA		
			DN	TRAÇO	POL.
TIDKO-30-20-10	M30X2.0	20	16	10	5/8"
TIDKO-30-20-12	M30X2.0	20	20	12	3/4"
TIDKO-36-25-12	M36X2.0	25	20	12	3/4"
TIDKO-36-25-16	M36X2.0	25	25	16	1"
TIDKO-42-30-12	M42X2.0	30	20	12	3/4"
TIDKO-42-30-16	M42X2.0	30	25	16	1"
TIDKO-42-30-20	M42X2.0	30	32	20	1.1/4"
TIDKO-52-38-16	M52X2.0	38	25	16	1"
TIDKO-52-38-20	M52X2.0	38	32	20	1.1/4"
TIDKO-52-38-24	M52X2.0	38	40	24	1.1/2"

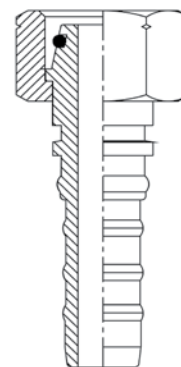

TIDKO45

FÊMEA GIRATÓRIA CURVA 45°
MÉTRICA DKO - INTERLOCK SEDE 24°/DIN 3865

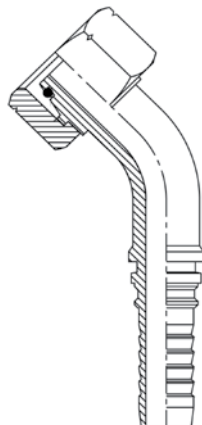

COD. ARAFLEX	ROSCA	DN TUBO	MANGUEIRA		
			DN	TRAÇO	POL.
TIDKO45-24-16-10	M24X2.0	16	16	10	5/8"
TIDKO45-30-20-10	M30X2.0	20	16	10	5/8"
TIDKO45-30-20-12	M30X2.0	20	20	12	3/4"
TIDKO45-36-25-12	M36X2.0	25	20	12	3/4"
TIDKO45-36-25-16	M36X2.0	25	25	16	1"
TIDKO45-42-30-10	M42X2.0	30	16	10	5/8"
TIDKO45-42-30-16	M42X2.0	30	25	16	1"
TIDKO45-42-30-20	M42X2.0	30	32	20	1.1/4"
TIDKO45-52-38-16	M52X2.0	38	14	16	1"
TIDKO45-52-38-20	M52X2.0	38	32	20	1.1/4"
TIDKO45-52-38-24	M52X2.0	38	40	24	1.1/2"

TERMINAIS INTERLOCK

TIDKO90

FÊMEA GIRATÓRIA CURVA 90°
MÉTRICA DKO - INTERLOCK SEDE 24°/DIN 3865

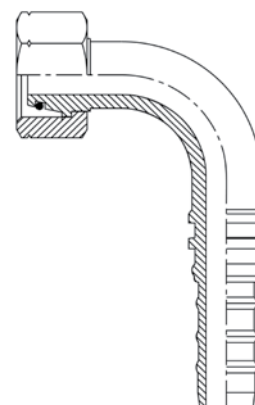

COD.ARAFLEX	ROSCA	DN TUBO	MANGUEIRA		
			DN	TRAÇO	POL.
TIDKO90-30-20-10	M30X2.0	20	16	10	5/8"
TIDKO90-30-20-12	M30X2.0	20	20	12	3/4"
TIDKO90-36-25-12	M36X2.0	25	20	12	3/4"
TIDKO90-36-25-16	M36X2.0	25	25	16	1"
TIDKO90-42-30-16	M42X2.0	30	25	16	1"
TIDKO90-42-30-20	M42X2.0	30	32	20	1.1/4"
TIDKO90-52-38-20	M52X2.0	38	32	20	1.1/4"

TIFGB

FÊMEA GIRATÓRIA RETA BSP - INTERLOCK SEDE 60°/BS 5200

COD. ARAFLEX	ROSCA	MANGUEIRA		
		DN	TRAÇO	POL.
TIFGB-12-12	3/4"X14	20	12	3/4"
TIFGB-12-16	3/4"X14	25	16	1"
TIFGB-16-12	1"X11	20	12	3/4"
TIFGB-16-16	1"X11	25	16	1"
TIFGB-20-16	1.1/4"X11	25	16	1"
TIFGB-20-20	1.1/4"X11	32	20	1.1/4"
TIFGB-24-20	1.1/2"X11	32	20	1.1/4"
TIFGB-24-24	1.1/2"X11	40	24	1.1/2"
TIFGB-32-32	2"X11	50	32	2"

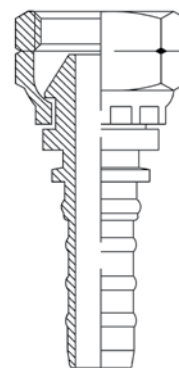

TIFGB45

FÊMEA GIRATÓRIA CURVA 45° BSP - INTERLOCK SEDE 60°/BS 5200

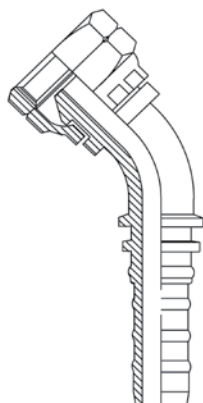

COD. ARAFLEX	ROSCA	MANGUEIRA		
		DN	TRAÇO	POL.
TIFGB45-12-12	3/4"X14	20	12	3/4"
TIFGB45-12-16	3/4"X14	25	16	1"
TIFGB45-16-12	1"X11	20	12	3/4"
TIFGB45-16-16	1"X11	25	16	1"
TIFGB45-20-16	1.1/4"X11	25	16	1"
TIFGB45-20-20	1.1/4"X11	32	20	1.1/4"
TIFGB45-24-20	1.1/2"X11	32	20	1.1/4"
TIFGB45-24-24	1.1/2"X11	40	24	1.1/2"
TIFGB45-32-32	2"X11	50	32	2"

TIFGB90

FÊMEA GIRATÓRIA CURVA 90° BSP - INTERLOCK SEDE 60°/BS 5200

COD. ARAFLEX	ROSCA	MANGUEIRA		
		DN	TRAÇO	POL.
TIFGB90-12-12	3/4"X14	20	12	3/4"
TIFGB90-12-16	3/4"X14	25	16	1"
TIFGB90-16-12	1"X11	20	12	3/4"
TIFGB90-16-16	1"X11	25	16	1"
TIFGB90-20-16	1.1/4"X11	25	16	1"
TIFGB90-20-20	1.1/4"X11	32	20	1.1/4"
TIFGB90-24-20	1.1/2"X11	32	20	1.1/4"
TIFGB90-24-24	1.1/2"X11	40	24	1.1/2"
TIFGB90-32-32	2"X11	50	32	2"

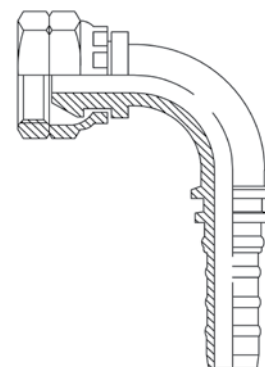

____/____/____
DATA

TÍTULO

Blank area with horizontal dashed lines for writing.

TERMINAIS INTERLOCK



Adaptadores

ADMJMJ

ADAPTADOR RETO MACHO JIC 37° X MACHO JIC 37°

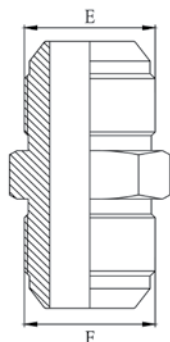

COD. ARAFLEX	ROSCA	
	E	F
ADMJMJ-04-04	7/16"X20	7/16"X20
ADMJMJ-05-04	1/2"X20	7/16"X20
ADMJMJ-05-05	1/2"X20	1/2"X20
ADMJMJ-06-04	9/16"X18	7/16"X20
ADMJMJ-06-05	9/16"X18	1/2"X20
ADMJMJ-06-06	9/16"X18	9/16"X18
ADMJMJ-08-04	3/4"X16	7/16"X20
ADMJMJ-08-06	3/4"X16	9/16"X18
ADMJMJ-08-08	3/4"X16	3/4"X16
ADMJMJ-10-06	7/8"X14	9/16"X18
ADMJMJ-10-08	7/8"X14	3/4"X16
ADMJMJ-10-10	7/8"X14	7/8"X14
ADMJMJ-12-06	1.1/16"X12	9/16"X18
ADMJMJ-12-08	1.1/16"X12	3/4"X16
ADMJMJ-12-10	1.1/16"X12	7/8"X14
ADMJMJ-12-12	1.1/16"X12	1.1/16"X12
ADMJMJ-16-08	1.5/16"X12	3/4"X16
ADMJMJ-16-10	1.5/16"X12	7/8"X14
ADMJMJ-16-12	1.5/16"X12	1.1/16"X12
ADMJMJ-16-16	1.5/16"X12	1.5/16"X12
ADMJMJ-20-16	1.5/8"X12	1.5/16"X12
ADMJMJ-20-20	1.5/8"X12	1.5/8"X12
ADMJMJ-24-20	1.7/8"X12	1.5/8"X12
ADMJMJ-24-24	1.7/8"X12	1.7/8"X12
ADMJMJ-32-20	2.1/2"X12	1.5/8"X12
ADMJMJ-32-24	2.1/2"X12	1.7/8"X12
ADMJMJ-32-32	2.1/2"X12	2.1/2"X12

AD90MJMJ

ADAPTADOR CURVA 90° MACHO JIC 37° X MACHO JIC 37°

COD. ARAFLEX	ROSCA	
	E	F
AD90MJMJ-04-04	7/16"X20	7/16"X20
AD90MJMJ-05-05	1/2"X20	1/2"X20
AD90MJMJ-06-06	9/16"X18	9/16"X18
AD90MJMJ-08-08	3/4"X16	3/4"X16
AD90MJMJ-10-10	7/8"X14	7/8"X14
AD90MJMJ-12-12	1.5/16"X12	1.5/16"X12
AD90MJMJ-16-16	1.5/8"X12	1.5/8"X12
AD90MJMJ-20-20	1.7/8"X12	1.7/8"X12
AD90MJMJ-24-24	2.1/2"X12	2.1/2"X12

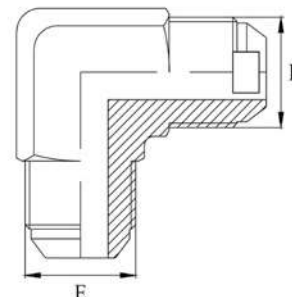

ADMJMJL

ADAPTADOR RETO MACHO JIC 37° X MACHO JIC 37° PAINEL / LONGO

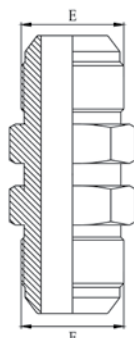

COD. ARAFLEX	ROSCA	
	E	F
ADMJMJL-04-04	7/16"X20	7/16"X20
ADMJMJL-06-06	9/16"X18	9/16"X18
ADMJMJL-08-08	3/4"X16	3/4"X16
ADMJMJL-10-10	7/8"X14	7/8"X14
ADMJMJL-12-12	1.1/16"X12	1.1/16"X12
ADMJMJL-16-16	1.5/16"X12	1.5/16"X12
ADMJMJL-20-20	1.5/8"X12	1.5/8"X12
ADMJMJL-24-24	1.7/8"X12	1.7/8"X12
ADMJMJL-32-32	2.1/2"X12	2.1/2"X12

AD90MJMJL

ADAPTADOR CURVA 90° MACHO JIC 37° X MACHO JIC 37° PAINEL / LONGO

COD. ARAFLEX	ROSCA	
	E	F
AD90MJMJL-04-04	7/16"X20	7/16"X20
AD90MJMJL-05-05	1/2"X20	1/2"X20
AD90MJMJL-06-06	9/16"X18	9/16"X18
AD90MJMJL-08-08	3/4"X16	3/4"X16
AD90MJMJL-10-10	7/8"X14	7/8"X14
AD90MJMJL-12-12	1.1/16"X12	1.1/16"X12
AD90MJMJL-16-16	1.5/16"X12	1.5/16"X12
AD90MJMJL-20-20	1.5/8"X12	1.5/8"X12
AD90MJMJL-24-24	1.7/8"X12	1.7/8"X12

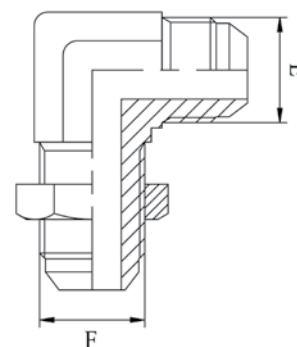

ADMJFJ

ADAPTADOR RETO MACHO JIC 37° X FÊMEA JIC 37°

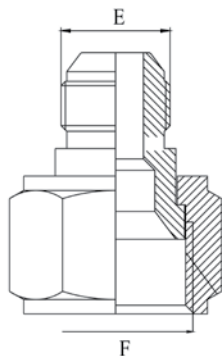

COD. ARAFLEX	ROSCA	
	E	F
ADMJFJ-04-06	7/16"X20	9/16"X18
ADMJFJ-04-08	7/16"X20	3/4"X16
ADMJFJ-04-10	7/16"X20	7/8"X14
ADMJFJ-04-12	7/16"X20	1.1/16"X12
ADMJFJ-05-08	1/2"X20	3/4"X16
ADMJFJ-05-10	1/2"X20	7/8"X14
ADMJFJ-05-12	1/2"X20	1.1/16"X12
ADMJFJ-06-08	9/16"X18	3/4"X16
ADMJFJ-06-10	9/16"X18	7/8"X14
ADMJFJ-06-12	9/16"X18	1.1/16"X12
ADMJFJ-06-16	9/16"X18	1.5/16"X12
ADMJFJ-08-12	3/4"X16	1.1/16"X12
ADMJFJ-08-16	3/4"X16	1.5/16"X12
ADMJFJ-08-20	3/4"X16	1.5/8"X12
ADMJFJ-10-16	7/8"X14	1.5/16"X12
ADMJFJ-10-20	7/8"X14	1.5/8"X12
ADMJFJ-10-24	7/8"X14	1.7/8"X12
ADMJFJ-12-16	1.1/16"X12	1.5/16"X12
ADMJFJ-12-20	1.1/16"X12	1.5/8"X12
ADMJFJ-12-24	1.1/16"X12	1.7/8"X12
ADMJFJ-16-20	1.5/16"X12	1.5/8"X12
ADMJFJ-16-24	1.5/16"X12	1.7/8"X12
ADMJFJ-20-24	1.5/8"X12	1.7/8"X12

AD45MJFJ

ADAPTADOR CURVA 45° MACHO JIC 37° X FÊMEA JIC 37°

COD. ARAFLEX	ROSCA	
	E	F
AD45MJFJ-04-04	7/16"X20	7/16"X20
AD45MJFJ-05-05	1/2"X20	1/2"X20
AD45MJFJ-06-06	9/16"X18	9/16"X18
AD45MJFJ-08-08	3/4"X16	3/4"X16
AD45MJFJ-10-10	7/8"X14	7/8"X14
AD45MJFJ-12-12	1.1/16"X12	1.1/16"X12
AD45MJFJ-16-16	1.5/16"X12	1.5/16"X12
AD45MJFJ-20-20	1.5/8"X12	1.5/8"X12
AD45MJFJ-24-24	1.7/8"X12	1.7/8"X12
AD45MJFJ-32-32	2.1/2"X12	2.1/2"X12

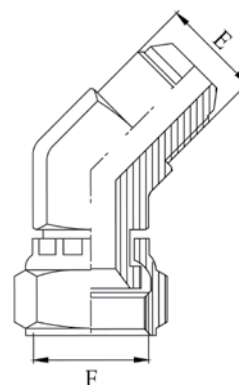

AD90MJFJ

ADAPTADOR CURVA 90° MACHO JIC 37° X FÊMEA JIC 37°

COD. ARAFLEX	ROSCA	
	E	F
AD90MJFJ-04-04	7/16"X20	7/16"X20
AD90MJFJ-05-05	1/2"X20	1/2"X20
AD90MJFJ-06-06	9/16"X18	9/16"X18
AD90MJFJ-06-08	9/16"X18	3/4"X16
AD90MJFJ-08-06	3/4"X16	9/16"X18
AD90MJFJ-08-08	3/4"X16	3/4"X16
AD90MJFJ-08-10	3/4"X16	7/8"X14
AD90MJFJ-10-08	7/8"X14	3/4"X16
AD90MJFJ-10-10	7/8"X14	7/8"X14
AD90MJFJ-10-12	7/8"X14	1.1/16"X12
AD90MJFJ-12-10	1.1/16"X12	7/8"X14
AD90MJFJ-12-12	1.1/16"X12	1.1/16"X12
AD90MJFJ-12-16	1.1/16"X12	1.5/16"X12
AD90MJFJ-16-16	1.5/16"X12	1.5/16"X12
AD90MJFJ-16-20	1.5/16"X12	1.5/8"X12
AD90MJFJ-20-16	1.5/8"X12	1.5/16"X12
AD90MJFJ-20-20	1.5/8"X12	1.5/8"X12
AD90MJFJ-20-24	1.5/8"X12	1.7/8"X12
AD90MJFJ-24-20	1.7/8"X12	1.5/8"X12
AD90MJFJ-24-24	1.7/8"X12	1.7/8"X12
AD90MJFJ-32-32	2.1/2"X12	2.1/2"X12

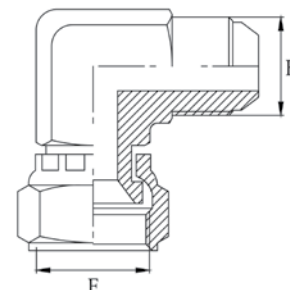

ADMJMO

ADAPTADOR RETO MACHO UNF X MACHO JIC 37° COM O'RING

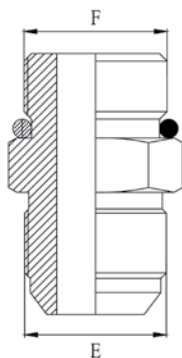

COD. ARAFLEX	ROSCA	
	E	F
ADMJMO-04-04	7/16"X20	7/16"X20
ADMJMO-04-05	7/16"X20	1/2"X20
ADMJMO-04-06	7/16"X20	9/16"X18
ADMJMO-05-04	1/2"X20	7/16"X20
ADMJMO-05-05	1/2"X20	1/2"X20
ADMJMO-05-06	1/2"X20	9/16"X18
ADMJMO-06-04	9/16"X18	7/16"X20
ADMJMO-06-05	9/16"X18	1/2"X20
ADMJMO-06-06	9/16"X18	9/16"X18
ADMJMO-06-08	9/16"X18	3/4"X16
ADMJMO-08-05	3/4"X16	1/2"X20
ADMJMO-08-06	3/4"X16	9/16"X18
ADMJMO-08-08	3/4"X16	3/4"X16
ADMJMO-08-10	3/4"X16	7/8"X14
ADMJMO-08-12	3/4"X16	1.1/16"X12
ADMJMO-10-06	7/8"X14	9/16"X18
ADMJMO-10-08	7/8"X14	3/4"X16
ADMJMO-10-10	7/8"X14	7/8"X14
ADMJMO-10-12	7/8"X14	1.1/16"X12
ADMJMO-12-08	1.1/16"X12	3/4"X16
ADMJMO-12-10	1.1/16"X12	7/8"X14
ADMJMO-12-12	1.1/16"X12	1.1/16"X12
ADMJMO-12-16	1.1/16"X12	1.5/16"X12
ADMJMO-16-12	1.5/16"X12	1.1/16"X12
ADMJMO-16-16	1.5/16"X12	1.5/16"X12
ADMJMO-20-20	1.5/8"X12	1.5/8"X12
ADMJMO-24-24	1.7/8"X12	1.7/8"X12
ADMJMO-32-32	2.1/2"X12	2.1/2"X12

AD45MJMO

ADAPTADOR CURVA 45° MACHO UNF X MACHO JIC 37° COM PORCA ORIENTÁVEL

COD. ARAFLEX	ROSCA	
	E	F
AD45MJMO-04-04	7/16"X20	7/16"X20
AD45MJMO-04-06	7/16"X20	9/16"X18
AD45MJMO-05-05	1/2"X20	1/2"X20
AD45MJMO-06-04	9/16"X18	7/16"X20
AD45MJMO-06-06	9/16"X18	9/16"X18
AD45MJMO-06-08	9/16"X18	3/4"X16
AD45MJMO-08-06	3/4"X16	9/16"X18
AD45MJMO-08-08	3/4"X16	3/4"X16
AD45MJMO-08-10	3/4"X16	7/8"X14
AD45MJMO-08-12	3/4"X16	1.1/16"X12
AD45MJMO-10-08	7/8"X14	3/4"X16
AD45MJMO-10-10	7/8"X14	7/8"X14
AD45MJMO-10-12	7/8"X14	1.1/16"X12
AD45MJMO-12-08	1.1/16"X12	3/4"X16
AD45MJMO-12-10	1.1/16"X12	7/8"X14
AD45MJMO-12-12	1.1/16"X12	1.1/16"X12
AD45MJMO-12-16	1.1/16"X12	1.5/16"X12
AD45MJMO-16-12	1.5/16"X12	1.1/16"X12
AD45MJMO-16-16	1.5/8"X12	1.5/16"X12
AD45MJMO-20-20	1.5/8"X12	1.5/8"X12

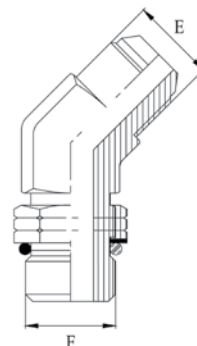

AD90MJMO

ADAPTADOR CURVA 90° MACHO UNF X MACHO JIC 37° COM PORCA ORIENTÁVEL

COD. ARAFLEX	ROSCA	
	E	F
AD90MJMO-04-04	7/16"X20	7/16"X20
AD90MJMO-04-06	7/16"X20	9/16"X18
AD90MJMO-05-05	1/2"X20	1/2"X20
AD90MJMO-06-04	9/16"X18	7/16"X20
AD90MJMO-06-06	9/16"X18	9/16"X18
AD90MJMO-06-08	9/16"X18	3/4"X16
AD90MJMO-08-06	3/4"X16	9/16"X18
AD90MJMO-08-08	3/4"X16	3/4"X16
AD90MJMO-08-10	3/4"X16	7/8"X14
AD90MJMO-08-12	3/4"X16	1.1/16"X12
AD90MJMO-10-08	7/8"X14	3/4"X16
AD90MJMO-10-10	7/8"X14	7/8"X14
AD90MJMO-10-12	7/8"X14	1.1/16"X12
AD90MJMO-12-08	1.1/16"X12	3/4"X16
AD90MJMO-12-10	1.1/16"X12	7/8"X14
AD90MJMO-12-12	1.1/16"X12	1.1/16"X12
AD90MJMO-12-16	1.1/16"X12	1.5/16"X12
AD90MJMO-16-12	1.5/16"X12	1.1/16"X12
AD90MJMO-16-16	1.5/16"X12	1.5/16"X12
AD90MJMO-20-20	1.5/8"X12	1.5/8"X12

ADMJMM

ADAPTADOR RETO MACHO JIC 37° X MACHO MÉTRICO COM O'RING

COD. ARAFLEX	ROSCA	
	E	F
ADMJMM-04-10	7/16"X20	10X1
ADMJMM-04-12	7/16"X20	12X1.5
ADMJMM-04-14	7/16"X20	14X1.5
ADMJMM-05-10	1/2"X20	10X1
ADMJMM-05-12	1/2"X20	12X1.5
ADMJMM-05-14	1/2"X20	14X1.5
ADMJMM-06-14	9/16"X18	14X1.5
ADMJMM-06-16	9/16"X18	16X1.5
ADMJMM-06-18	9/16"X18	18X1.5
ADMJMM-08-14	3/4"X16	14X1.5
ADMJMM-08-16	3/4"X16	16X1.5
ADMJMM-08-18	3/4"X16	18X1.5
ADMJMM-08-22	3/4"X16	22X1.5
ADMJMM-10-16	7/8"X14	16X1.5
ADMJMM-10-18	7/8"X14	18X1.5
ADMJMM-10-22	7/8"X14	22X1.5
ADMJMM-12-22	1.1/16"X12	22X1.5
ADMJMM-12-27	1.1/16"X12	27X2
ADMJMM-16-27	1.5/16"X12	27X2

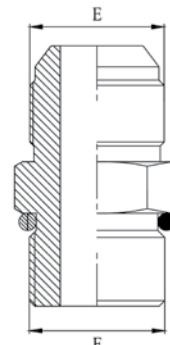

AD45MJMM

ADAPTADOR CURVA 45° MACHO JIC 37° X MACHO MÉTRICO COM PORCA ORIENTÁVEL

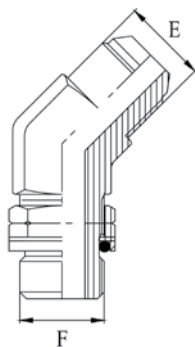

COD. ARAFLEX	ROSCA	
	E	F
AD45MJMM-04-10	7/16"X20	10X1
AD45MJMM-04-12	7/16"X20	12X1.5
AD45MJMM-04-14	7/16"X20	14X1.5
AD45MJMM-05-12	1/2"X20	12X1.5
AD45MJMM-05-14	1/2"X20	14X1.5
AD45MJMM-06-14	9/16"X18	14X1.5
AD45MJMM-06-16	9/16"X18	16X1.5
AD45MJMM-06-18	9/16"X18	18X1.5
AD45MJMM-08-16	3/4"X16	16X1.5
AD45MJMM-08-18	3/4"X16	18X1.5
AD45MJMM-08-22	3/4"X16	22X1.5
AD45MJMM-10-16	7/8"X14	16X1.5
AD45MJMM-10-18	7/8"X14	18X1.5
AD45MJMM-10-22	7/8"X14	22X1.5
AD45MJMM-12-22	1.1/16"X12	22X1.5
AD45MJMM-12-27	1.1/16"X12	27X2
AD45MJMM-16-27	1.5/16"X12	27X2
AD90MJMO-16-12	1.5/16"X12	1.1/16"X12
AD90MJMO-16-16	1.5/16"X12	1.5/16"X12
AD90MJMO-20-20	1.5/8"X12	1.5/8"X12

AD90MJMM

ADAPTADOR CURVA 90° MACHO JIC 37° X MACHO MÉTRICO COM PORCA ORIENTÁVEL

COD. ARAFLEX	ROSCA	
	E	F
AD90MJMM-04-10	7/16"X20	10X1
AD90MJMM-04-12	7/16"X20	12X1.5
AD90MJMM-04-14	7/16"X20	14X1.5
AD90MJMM-05-12	1/2"X20	12X1.5
AD90MJMM-05-14	1/2"X20	14X1.5
AD90MJMM-06-14	9/16"X18	14X1.5
AD90MJMM-06-16	9/16"X18	16X1.5
AD90MJMM-06-18	9/16"X18	18X1.5
AD90MJMM-08-16	3/4"X16	16X1.5
AD90MJMM-08-18	3/4"X16	18X1.5
AD90MJMM-08-22	3/4"X16	22X1.5
AD90MJMM-10-16	7/8"X14	16X1.5
AD90MJMM-10-18	7/8"X14	18X1.5
AD90MJMM-10-22	7/8"X14	22X1.5
AD90MJMM-12-22	1.1/16"X12	22X1.5
AD90MJMM-12-27	1.1/16"X12	27X2
AD90MJMM-16-27	1.5/16"X12	27X2

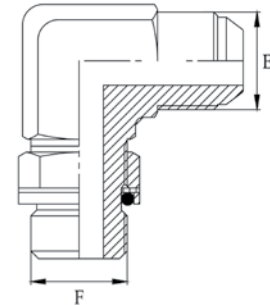

ADMJMSP

ADAPTADOR RETO MACHO JIC 37° X MACHO ORFS SEDE PLANA

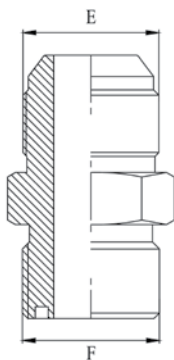

COD. ARAFLEX	ROSCA	
	E	F
ADMJMSP-04-04	7/16"X20	9/16"X18
ADMJMSP-05-04	1/2"X20	9/16"X18
ADMJMSP-05-06	1/2"X20	11/16"X16
ADMJMSP-06-04	9/16"X18	9/16"X18
ADMJMSP-08-06	3/4"X16	11/16"X16
ADMJMSP-08-08	3/4"X16	13/16"X16
ADMJMSP-10-08	7/8"X14	13/16"X16
ADMJMSP-10-10	7/8"X14	1"X14
ADMJMSP-12-10	1.1/16"X12	1"X14
ADMJMSP-12-12	1.1/16"X12	1.3/16"X12
ADMJMSP-16-12	1.5/16"X12	1.3/16"X12
ADMJMSP-16-16	1.5/16"X12	1.7/16"X12
ADMJMSP-20-16	1.5/8"X12	1.7/16"X12
ADMJMSP-20-20	1.5/8"X12	1.11/16"X12
ADMJMSP-24-20	1.7/8"X12	1.11/16"X12

ADMJFFP

ADAPTADOR RETO MACHO JIC 37° X FÊMEA FIXA NPT

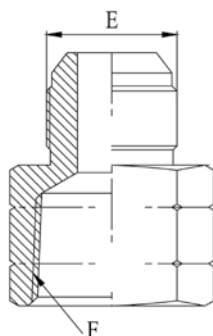

COD. ARAFLEX	ROSCA	
	E	F
ADMJFFP-04-02	7/16"X20	1/8"X27
ADMJFFP-04-04	7/16"X20	1/4"X18
ADMJFFP-05-04	1/2"X20	1/4"X18
ADMJFFP-06-04	9/16"X18	1/4"X18
ADMJFFP-06-06	9/16"X18	3/8"X18
ADMJFFP-06-08	9/16"X18	1/2"X14
ADMJFFP-08-06	3/4"X16	3/8"X18
ADMJFFP-08-08	3/4"X16	1/2"X14
ADMJFFP-08-12	3/4"X16	3/4"X14
ADMJFFP-10-08	7/8"X14	1/2"X14
ADMJFFP-10-12	7/8"X14	3/4"X14
ADMJFFP-12-08	1.1/16"X12	1/2"X14
ADMJFFP-12-12	1.1/16"X12	3/4"X14
ADMJFFP-16-12	1.5/16"X12	3/4"X14
ADMJFFP-16-16	1.5/16"X12	1"X11.5
ADMJFFP-20-20	1.5/8"X12	1.1/4"X11.5
ADMJFFP-24-24	1.7/8"X12	1.1/2"X11.5
ADMJFFP-32-32	2.1/2"X12	2"X11.5

AD90MJFFP

ADAPTADOR CURVA 90° MACHO JIC 37° X FÊMEA FIXA NPT

COD. LENZ	ROSCA	
	E	F
AD90MJFFP-04-02	7/16"X20	1/8"X27
AD90MJFFP-04-04	7/16"X20	1/4"X18
AD90MJFFP-05-02	1/2"X20	1/8"X27
AD90MJFFP-05-04	9/16"X18	1/4"X18
AD90MJFFP-06-02	9/16"X18	1/8"X27
AD90MJFFP-06-04	9/16"X18	1/4"X18
AD90MJFFP-06-06	9/16"X18	3/8"X18
AD90MJFFP-08-04	3/4"X16	1/4"X18
AD90MJFFP-08-06	3/4"X16	3/8"X18
AD90MJFFP-08-08	3/4"X16	1/2"X14
AD90MJFFP-10-08	7/8"X14	1/2"X14
AD90MJFFP-12-08	1.1/16"X12	1/2"X14
AD90MJFFP-12-12	1.1/16"X12	3/4"X14
AD90MJFFP-16-16	1.5/16"X12	1"X11.5
AD90MJFFP-20-20	1.5/8"X12	1.1/4"X11.5
AD90MJFFP-24-24	1.7/8"X12	1.1/2"X11.5



ADMJMB

ADAPTADOR RETO MACHO JIC 37° X MACHO BSP COM O'RING

COD. ARAFLEX	ROSCA	
	E	F
ADMJMB-04-02	7/16"X20	1/8"X28
ADMJMB-04-04	7/16"X20	1/4"X19
ADMJMB-04-06	7/16"X20	3/8"X19
ADMJMB-04-08	7/16"X20	1/2"X14
ADMJMB-05-04	1/2"X20	1/4"X19
ADMJMB-05-06	1/2"X20	3/8"X19
ADMJMB-05-08	1/2"X20	1/2"X14
ADMJMB-06-04	9/16"X18	1/4"X19
ADMJMB-06-06	9/16"X18	3/8"X19
ADMJMB-06-08	9/16"X18	1/2"X14
ADMJMB-08-04	3/4"X16	1/4"X19
ADMJMB-08-06	3/4"X16	3/8"X19
ADMJMB-08-08	3/4"X16	1/2"X14
ADMJMB-08-12	3/4"X16	3/4"X14
ADMJMB-10-06	7/8"X14	3/8"X19
ADMJMB-10-08	7/8"X14	1/2"X14
ADMJMB-10-12	7/8"X14	3/4"X14
ADMJMB-12-08	1.1/16"X12	1/2"X14
ADMJMB-12-12	1.1/16"X12	3/4"X14
ADMJMB-12-16	1.1/16"X12	1"X11
ADMJMB-12-20	1.1/16"X12	1.1/4"X11
ADMJMB-16-12	1.5/16"X12	3/4"X14
ADMJMB-16-16	1.5/16"X12	1"X11
ADMJMB-16-20	1.5/16"X12	1.1/4"X11
ADMJMB-20-16	1.5/8"X12	1"X11
ADMJMB-20-20	1.5/8"X12	1.1/4"X11
ADMJMB-24-16	1.7/8"X12	1"X11
ADMJMB-24-20	1.7/8"X12	1.1/4"X11
ADMJMB-24-24	1.7/8"X12	1.1/2"X11

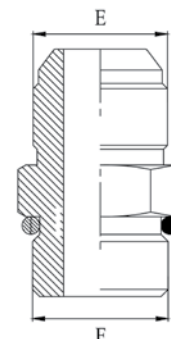

AD45MJMB

ADAPTADOR CURVA 45° MACHO JIC 37° X MACHO
BSP COM PORCA ORIENTÁVEL

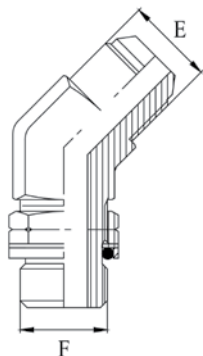

COD. ARAFLEX	ROSCA	
	E	F
AD45MJMB-04-02	7/16X20	1/8"X28
AD45MJMB-04-04	7/16"X20	1/4"X19
AD45MJMB-04-06	7/16"X20	3/8"X19
AD45MJMB-04-08	7/16"X20	1/2"X14
AD45MJMB-05-04	1/2"X20	1/4"X19
AD45MJMB-06-04	9/16"X18	1/4"X19
AD45MJMB-06-06	9/16"X18	3/8"X19
AD45MJMB-06-08	9/16"X18	1/2"X14
AD45MJMB-08-06	3/4"X16	3/8"X19
AD45MJMB-08-08	3/4"X16	1/2"X14
AD45MJMB-08-12	3/4"X16	3/4"X14
AD45MJMB-10-06	7/8"X14	3/8"X19
AD45MJMB-10-08	7/8"X14	1/2"X14
AD45MJMB-10-10	7/8"X14	5/8"X14
AD45MJMB-10-12	7/8"X14	3/4"X14
AD45MJMB-12-08	1.1/16"X12	1/2"X14
AD45MJMB-12-12	1.1/16"X12	3/4"X14
AD45MJMB-12-16	1.1/16"X12	1"X11
AD45MJMB-16-12	1.5/16"X12	3/4"X14
AD45MJMB-16-16	1.5/16"X12	1"X11
AD45MJMB-16-20	1.5/16"X12	1.1/4"X11
AD45MJMB-20-20	1.5/8"X12	1.1/4"X11
AD45MJMB-24-24	1.7/8"X12	1.1/2"X11

AD90MJMB

ADAPTADOR CURVA 90° MACHO JIC 37° X MACHO BSP COM PORCA ORIENTÁVEL

COD. ARAFLEX	ROSCA	
	E	F
AD90MJMB-04-02	7/16"X20	1/8"X28
AD90MJMB-04-04	7/16"X20	1/4"X19
AD90MJMB-04-06	7/16"X20	3/8"X19
AD90MJMB-04-08	7/16"X20	1/2"X14
AD90MJMB-05-04	1/2"X20	1/4"X19
AD90MJMB-05-06	1/2"X20	3/8"X19
AD90MJMB-05-08	1/2"X20	1/2"X14
AD90MJMB-06-04	9/16"X18	1/4"X19
AD90MJMB-06-06	9/16"X18	3/8"X19
AD90MJMB-06-08	9/16"X18	1/2"X14
AD90MJMB-08-04	3/4"X16	1/4"X19
AD90MJMB-08-06	3/4"X16	3/8"X19
AD90MJMB-08-08	3/4"X16	1/2"X14
AD90MJMB-08-12	3/4"X16	3/4"X14
AD90MJMB-10-06	7/8"X16	3/8"X19
AD90MJMB-10-08	7/8"X16	1/2"X14
AD90MJMB-10-12	7/8"X16	3/4"X14
AD90MJMB-12-08	1.1/16"X12	1/2"X14
AD90MJMB-12-12	1.1/16"X12	3/4"X14
AD90MJMB-12-16	1.1/16"X12	1"X11
AD90MJMB-16-12	1.5/16"X12	3/4"X14
AD90MJMB-16-16	1.5/16"X12	1"X11
AD90MJMB-16-20	1.5/16"X12	1.1/4"X11
AD90MJMB-20-16	1.5/8"X12	1"X11
AD90MJMB-20-20	1.5/8"X12	1.1/4"X11
AD90MJMB-24-16	1.7/8"X12	1"X11
AD90MJMB-24-20	1.7/8"X12	1.1/4"X11
AD90MJMB-24-24	1.7/8"X12	1.1/2"X11

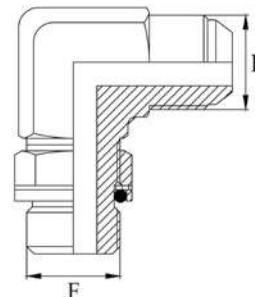

ADMJFL3

ADAPTADOR RETO MACHO JIC 37° X FLANGE CÓD 61

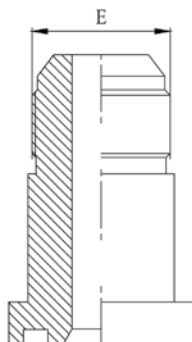

COD. ARAFLEX	ROSCA E	FLANGE	
ADMJFL3-08-08	3/4"X16	1/2"	30.2 MM
ADMJFL3-08-12	3/4"X16	3/4"	38.1 MM
ADMJFL3-10-08	7/8"X14	1/2"	30.2 MM
ADMJFL3-10-12	7/8"X14	3/4"	38.1 MM
ADMJFL3-12-08	1.1/16"X12	1/2"	30.2 MM
ADMJFL3-12-12	1.1/16"X12	3/4"	38.1 MM
ADMJFL3-16-12	1.5/16"X12	3/4"	38.1 MM
ADMJFL3-16-16	1.5/16"X12	1"	44.4 MM
ADMJFL3-16-20	1.5/16"X12	1.1/4"	50.8 MM
ADMJFL3-20-16	1.5/8"X12	1"	44.4 MM
ADMJFL3-20-20	1.5/8"X12	1.1/4"	50.8 MM
ADMJFL3-20-24	1.5/8"X12	1.1/2"	60.3 MM
ADMJFL3-24-20	1.7/8"X12	1.1/4"	50.8 MM
ADMJFL3-24-24	1.7/8"X12	1.1/2"	60.3 MM
ADMJFL3-24-32	1.7/8"X12	2"	71.4 MM
ADMJFL3-32-32	2.1/2"X12	2"	71.4 MM

AD45MJFL3

ADAPTADOR CURVA 45° MACHO JIC 37° X FLANGE CÓD 61

COD. ARAFLEX	ROSCA E	FLANGE	
AD45MJFL3-08-08	3/4"X16	1/2"	30.2 MM
AD45MJFL3-10-08	7/8"X14	1/2"	30.2 MM
AD45MJFL3-10-12	7/8"X14	3/4"	38.1 MM
AD45MJFL3-12-12	1.1/16"X12	3/4"	38.1 MM
AD45MJFL3-12-16	1.1/16"X12	1"	44.4 MM
AD45MJFL3-16-12	1.5/16"X12	3/4"	38.1 MM
AD45MJFL3-16-16	1.5/16"X12	1"	44.4 MM
AD45MJFL3-16-20	1.5/16"X12	1.1/4"	50.8 MM
AD45MJFL3-20-16	1.5/8"X12	1"	44.4 MM
AD45MJFL3-20-20	1.5/8"X12	1.1/4"	50.8 MM
AD45MJFL3-20-24	1.5/8"X12	1.1/2"	60.3 MM
AD45MJFL3-24-20	1.7/8"X12	1.1/4"	50.8 MM
AD45MJFL3-24-24	1.7/8"X12	1.1/2"	60.3 MM
AD45MJFL3-32-32	2.1/2"X12	2"	71.4 MM

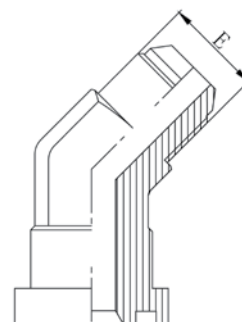

AD90MJFL3

ADAPTADOR CURVA 90° MACHO JIC 37° X FLANGE CÓD 61

COD. ARAFLEX	ROSCA E	FLANGE	
AD90MJFL3-08-08	3/4"X16	1/2"	30.2 MM
AD90MJFL3-10-08	7/8"X14	1/2"	30.2 MM
AD90MJFL3-10-12	7/8"X14	3/4"	38.1 MM
AD90MJFL3-12-12	1.1/16"X12	3/4"	38.1 MM
AD90MJFL3-12-16	1.1/16"X12	1"	44.4 MM
AD90MJFL3-16-12	1.5/16"X12	3/4"	38.1 MM
AD90MJFL3-16-16	1.5/16"X12	1"	44.4 MM
AD90MJFL3-16-20	1.5/16"X12	1.1/4"	50.8 MM
AD90MJFL3-20-16	1.5/8"X12	1"	44.4 MM
AD90MJFL3-20-20	1.5/8"X12	1.1/4"	50.8 MM
AD90MJFL3-20-24	1.5/8"X12	1.1/2"	60.3 MM
AD90MJFL3-24-20	1.7/8"X12	1.1/4"	50.8 MM
AD90MJFL3-24-24	1.7/8"X12	1.1/2"	60.3 MM
AD90MJFL3-32-32	2.1/2"X12	2"	71.4 MM

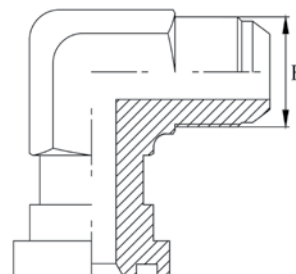

ADMJFL6

ADAPTADOR RETO MACHO JIC 37° X FLANGE CÓD 62

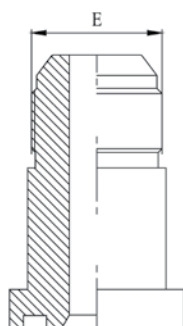

COD. ARAFLEX	ROSCA E	FLANGE	
ADMJFL6-08-08	3/4"X16	1/2"	31.7 MM
ADMJFL6-10-08	7/8"X14	1/2"	31.7 MM
ADMJFL6-10-12	7/8"X14	3/4"	41.3 MM
ADMJFL6-12-12	1.1/16"X12	3/4"	41.3 MM
ADMJFL6-12-16	1.1/16"X12	1"	47.6 MM
ADMJFL6-16-12	1.5/16"X12	3/4"	41.3 MM
ADMJFL6-16-16	1.5/16"X12	1"	47.6 MM
ADMJFL6-16-20	1.5/16"X12	1.1/4"	54.0 MM
ADMJFL6-20-16	1.5/8"X12	1"	47.6 MM
ADMJFL6-20-20	1.5/8"X12	1.1/4"	54.0 MM
ADMJFL6-20-24	1.5/8"X12	1.1/2"	63.5 MM
ADMJFL6-24-20	1.7/8"X12	1.1/4"	54.0 MM
ADMJFL6-24-24	1.7/8"X12	1.1/2"	63.5 MM

AD45MJFL6

ADAPTADOR CURVA 45° MACHO JIC 37° X FLANGE CÓD 62

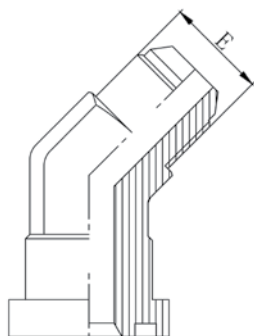

COD. ARAFLEX	ROSCA E	FLANGE	
AD45MJFL6-08-08	3/4"X16	1/2"	31.7 MM
AD45MJFL6-10-08	7/8"X14	1/2"	31.7 MM
AD45MJFL6-10-12	7/8"X14	3/4"	41.3 MM
AD45MJFL6-12-12	1.1/16"X12	3/4"	41.3 MM
AD45MJFL6-12-16	1.1/16"X12	1"	47.6 MM
AD45MJFL6-16-12	1.5/16"X12	3/4"	41.3 MM
AD45MJFL6-16-16	1.5/16"X12	1"	47.6 MM
AD45MJFL6-16-20	1.5/16"X12	1.1/4"	54.0 MM
AD45MJFL6-20-16	1.5/8"X12	1"	47.6 MM
AD45MJFL6-20-20	1.5/8"X12	1.1/4"	54.0 MM
AD45MJFL6-20-24	1.5/8"X12	1.1/2"	63.5 MM
AD45MJFL6-24-24	1.7/8"X12	1.1/2"	63.5 MM

AD90MJFL6

ADAPTADOR CURVA 90° MACHO JIC 37° X FLANGE CÓD 62

COD. ARAFLEX	ROSCA E	FLANGE	
AD90MJFL6-08-08	3/4"X16	1/2"	31.7 MM
AD90MJFL6-10-08	7/8"X14	1/2"	31.7 MM
AD90MJFL6-10-12	7/8"X14	3/4"	41.3 MM
AD90MJFL6-12-12	1.1/16"X12	3/4"	41.3 MM
AD90MJFL6-12-16	1.1/16"X12	1"	47.6 MM
AD90MJFL6-16-12	1.5/16"X12	3/4"	41.3 MM
AD90MJFL6-16-16	1.5/16"X12	1"	47.6 MM
AD90MJFL6-16-22	1.5/16"X12	1.1/4"	54.0 MM
AD90MJFL6-20-16	1.5/8"X12	1"	47.6 MM
AD90MJFL6-20-20	1.5/8"X12	1.1/4"	54.0 MM
AD90MJFL6-20-24	1.5/8"X12	1.1/2"	63.5 MM
AD90MJFL6-24-24	1.7/8"X12	1.1/2"	63.5 MM

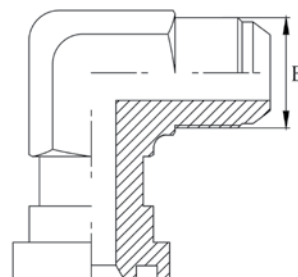

ADMJS

ADAPTADOR MACHO SOLDA JIC 37°

COD. ARAFLEX	ROSCA E	ENCAIXE SOLDA D1 (MM)
ADMJS-04-06	7/16"X20	6
ADMJS-05-08	1/2"X20	8
ADMJS-06-10	9/16"X18	10
ADMJS-08-12	3/4"X16	12
ADMJS-10-16	7/8"X14	16
ADMJS-12-20	1.1/16"X12	20
ADMJS-16-25	1.5/16"X12	25
ADMJS-20-32	1.5/8"X12	32

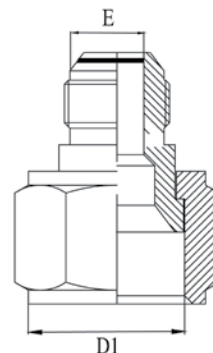

ADCMJ

ADAPTADOR CRUZETA MACHO JIC 37°

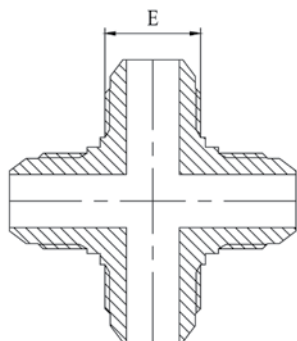

COD. ARAFLEX	ROSCA JIC 37°
ADCMJ-04-04	7/16"X20
ADCMJ-05-05	1/2"X20
ADCMJ-06-06	9/16"X18
ADCMJ-08-08	3/4"X16
ADCMJ-10-10	7/8"X14
ADCMJ-12-12	1.1/16"X12
ADCMJ-16-16	1.5/16"X12
ADCMJ-20-20	1.5/8"X12
ADCMJ-24-24	1.7/8"X12

ADMPMP

ADAPTADOR RETO MACHO NPT X MACHO NPT

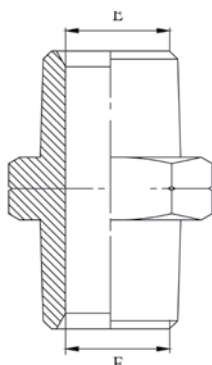

COD. ARAFLEX	ROSCA	
	E	F
ADMPMP-02-02	1/8"X27	1/8"X27
ADMPMP-02-04	1/8"X27	1/4"X18
ADMPMP-02-06	1/8"X27	3/8"X18
ADMPMP-04-04	1/4"X18	1/4"X18
ADMPMP-04-06	1/4"X18	3/8"X18
ADMPMP-04-08	1/4"X18	1/2"X14
ADMPMP-06-06	3/8"X18	3/8"X18
ADMPMP-06-08	3/8"X18	1/2"X14
ADMPMP-08-08	1/2"X14	1/2"X14
ADMPMP-08-12	1/2"X14	3/4"X14
ADMPMP-12-12	3/4"X14	3/4"X14
ADMPMP-12-16	3/4"X14	1"X11.5
ADMPMP-16-16	1"X11.5	1"X11.5
ADMPMP-16-20	1"X11.5	1.1/4"X11.5
ADMPMP-20-20	1.1/4"X11.5	1.1/4"X11.5
ADMPMP-20-24	1.1/4"X11.5	1.1/2"X11.5
ADMPMP-24-24	1.1/2"X11.5	1.1/2"X11.5
ADMPMP-24-32	1.1/2"X11.5	2"X11.5
ADMPMP-32-32	2"X11.5	2"X11.5

AD45MPMP

ADAPTADOR CURVA 45° MACHO NPT X MACHO NPT

COD. ARAFLEX	ROSCA	
	E	F
AD45MPMP-02-02	1/8"X27	1/8"X27
AD45MPMP-02-04	1/8"X18	1/4"X18
AD45MPMP-02-06	1/8"X18	3/8"X18
AD45MPMP-04-04	1/4"X18	1/4"X18
AD45MPMP-04-06	1/4"X18	3/8"X18
AD45MPMP-04-08	1/4"X18	1/2"X14
AD45MPMP-06-06	3/8"X18	3/8"X18
AD45MPMP-06-08	3/8"X18	1/2"X14
AD45MPMP-08-08	1/2"X14	1/2"X14
AD45MPMP-08-12	1/2"X14	3/4"X14
AD45MPMP-12-12	3/4"X14	3/4"X14
AD45MPMP-12-16	3/4"X14	1"X11.5
AD45MPMP-16-16	1"X11.5	1"X11.5
AD45MPMP-16-20	1"X11.5	1.1/4"X11.5
AD45MPMP-20-20	1.1/4"X11.5	1.1/4"X11.5
AD45MPMP-24-24	1.1/2"X11.5	1.1/2"X11.5
AD45MPMP-32-32	2"X11.5	2"X11.5

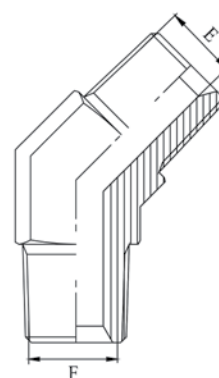

AD90MPMP

ADAPTADOR CURVA 90° MACHO NPT X MACHO NPT

COD. ARAFLEX	ROSCA	
	E	F
AD90MPMP-02-02	1/8"X27	1/8"X27
AD90MPMP-02-04	1/8"X27	1/4"X18
AD90MPMP-02-06	1/8"X27	3/8"X18
AD90MPMP-04-04	1/4"X18	1/4"X18
AD90MPMP-04-06	1/4"X18	3/8"X18
AD90MPMP-04-08	1/4"X18	1/2"X14
AD90MPMP-06-06	3/8"X18	3/8"X18
AD90MPMP-06-08	3/8"X18	1/2"X18
AD90MPMP-08-08	1/2"X14	1/2"X14
AD90MPMP-08-12	1/2"X14	3/4"X14
AD90MPMP-12-12	3/4"X14	3/4"X14
AD90MPMP-12-16	3/4"X14	1"X11.5
AD90MPMP-16-16	1"X11.5	1"X11.5
AD90MPMP-16-20	1"X11.5	1.1/4"X11.5
AD90MPMP-20-20	1.1/4"X11.5	1.1/4"X11.5
AD90MPMP-24-24	1.1/2"X11.5	1.1/2"X11.5
AD90MPMP-32-32	2"X11.5	2"X11.5

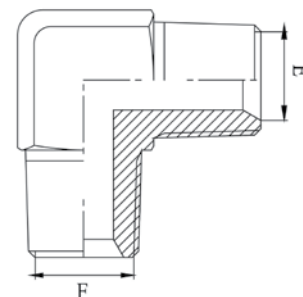

ADMPFF

ADAPTADOR RETO MACHO NPT X FÊMEA NPT

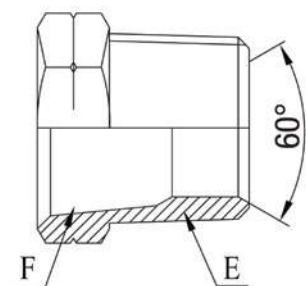

COD. ARAFLEX	ROSCA	
	E	F
ADMPFF-02-02	1/8"X27	1/8"X27
ADMPFF-02-04	1/8"X27	1/4"X18
ADMPFF-02-06	1/8"X27	3/8"X18
ADMPFF-02-08	1/8"X27	1/2"X14
ADMPFF-04-02	1/4"X18	1/8"X27
ADMPFF-04-04	1/4"X18	1/4"X18
ADMPFF-04-06	1/4"X18	3/8"X18
ADMPFF-04-08	1/4"X18	1/2"X14
ADMPFF-04-12	1/4"X18	3/4"X14
ADMPFF-06-04	3/8"X18	1/4"X18
ADMPFF-06-06	3/8"X18	3/8"X18
ADMPFF-06-08	3/8"X18	1/2"X14
ADMPFF-06-12	3/8"X18	3/4"X14
ADMPFF-06-16	3/8"X18	1"X11.5
ADMPFF-08-06	1/2"X14	3/8"X18
ADMPFF-08-12	1/2"X14	3/4"X14
ADMPFF-08-16	1/2"X14	1"X11.5
ADMPFF-12-08	3/4"X14	1/2"X14
ADMPFF-12-16	3/4"X14	1"X11.5
ADMPFF-12-20	3/4"X14	1.1/4"X11.5
ADMPFF-16-12	1"X11.5	3/4"X14
ADMPFF-16-16	1"X11.5	1"X11.5
ADMPFF-16-20	1"X11.5	1.1/4"X11.5
ADMPFF-16-24	1"X11.5	1.1/2"X11.5
ADMPFF-16-32	1"X11.5	2"X11.5
ADMPFF-20-12	1.1/4"X11.5	3/4"X14
ADMPFF-20-24	1.1/4"X11.5	1.1/2"X11.5
ADMPFF-20-32	1.1/4"X11.5	2"X11.5
ADMPFF-24-32	1.1/2"X11.5	2"X11.5

AD45MPFF

ADAPTADOR CURVA 45° MACHO NPT X FÊMEA NPT

COD. ARAFLEX	ROSCA	
	E	F
AD45MPFF-02-02	1/8"X27	1/8"X27
AD45MPFF-04-04	1/4"X18	1/4"X18
AD45MPFF-06-06	3/8"X18	3/8"X18
AD45MPFF-08-08	1/2"X14	1/2"X14
AD45MPFF-12-12	3/4"X14	3/4"X14
AD45MPFF-16-16	1"X11.5	1"X11.5
AD45MPFF-20-20	1.1/4"X11.5	1.1/4"X11.5
AD45MPFF-24-24	1.1/2"X11.5	1.1/2"X11.5
AD45MPFF-32-32	2"X11.5	2"X11.5

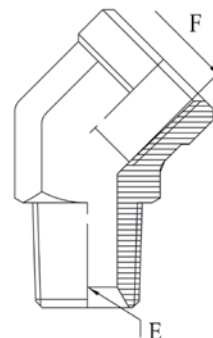

AD90MPFF

ADAPTADOR CURVA 90° MACHO NPT X FÊMEA NPT

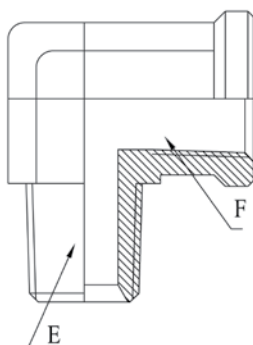

COD. ARAFLEX	ROSCA	
	E	F
AD90MPFF-02-02	1/8"X27	1/8"X27
AD90MPFF-04-02	1/4"X18	1/8"X27
AD90MPFF-04-04	1/4"X18	1/4"X18
AD90MPFF-04-06	1/4"X18	3/8"X18
AD90MPFF-06-06	3/8"X18	3/8"X18
AD90MPFF-08-08	1/2"X14	1/2"X14
AD90MPFF-12-08	3/4"X14	1/2"X14
AD90MPFF-12-12	3/4"X14	3/4"X14
AD90MPFF-16-16	1"X11.5	1"X11.5
AD90MPFF-20-20	1.1/4"X11.5	1.1/4"X11.5
AD90MPFF-24-24	1.1/2"X11.5	1.1/2"X11.5
AD90MPFF-32-32	2"X11.5	2"X11.5

ADFFFF

ADAPTADOR RETO FÊMEA NPT X FÊMEA NPT

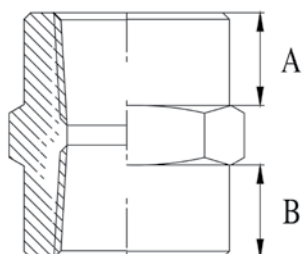

COD. ARAFLEX	ROSCA	
	A	B
ADFFFF-02-02	1/8"X27	1/8"X27
ADFFFF-04-02	1/4"X18	1/8"X27
ADFFFF-04-04	1/4"X18	1/4"X18
ADFFFF-06-04	3/8"X18	1/4"X18
ADFFFF-06-06	3/8"X18	3/8"X18
ADFFFF-08-04	1/2"X14	1/4"X18
ADFFFF-08-08	1/2"X14	1/2"X14
ADFFFF-12-12	3/4"X14	3/4"X14
ADFFFF-16-16	1"X11.5	1"X11.5
ADFFFF-20-20	1.1/4"X11.5	1.1/4"X11.5
ADFFFF-24-24	1.1/2"X11.5	1.1/2"X11.5
ADFFFF-32-32	2"X11.5	2"X11.5

AD90FFFF

ADAPTADOR CURVA 90° FÊMEA NPT X FÊMEA NPT

COD. ARAFLEX	ROSCA	
	E	F
AD90FFFF-02-02	1/8"X27	1/8"X27
AD90FFFF-02-04	1/8"X27	1/4"X18
AD90FFFF-04-04	1/4"X18	1/4"X18
AD90FFFF-06-04	3/8"X18	1/4"X18
AD90FFFF-06-06	3/8"X18	3/8"X18
AD90FFFF-08-04	1/2"X14	1/4"X18
AD90FFFF-08-08	1/2"X14	1/2"X14
AD90FFFF-12-12	3/4"X14	3/4"X14
AD90FFFF-16-16	1"X11.5	1"X11.5
AD90FFFF-20-20	1.1/4"X11.5	1.1/4"X11.5
AD90FFFF-24-24	1.1/2"X11.5	1.1/2"X11.5
AD90FFFF-32-32	2"X11.5	2"X11.5

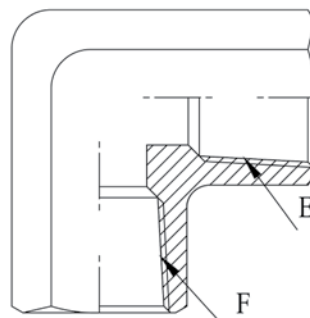

ADMPMJ

ADAPTADOR RETO MACHO NPT X MACHO JIC 37°

COD. ARAFLEX	ROSCA	
	F	E
ADMPMJ-02-04	1/8"X27	7/16"X20
ADMPMJ-02-05	1/8"X27	1/2"X20
ADMPMJ-02-06	1/8"X27	9/16"X18
ADMPMJ-04-04	1/4"X18	7/16"X20
ADMPMJ-04-05	1/4"X18	1/2"X20
ADMPMJ-04-06	1/4"X18	9/16"X18
ADMPMJ-04-08	1/4"X18	3/4"X16
ADMPMJ-06-04	3/8"X18	7/16"X20
ADMPMJ-06-05	3/8"X18	1/2"X20
ADMPMJ-06-06	3/8"X18	9/16"X18
ADMPMJ-06-08	3/8"X18	3/4"X16
ADMPMJ-06-10	3/8"X18	7/8"X14
ADMPMJ-06-12	3/8"X18	1.1/16"X12
ADMPMJ-08-04	1/2"X14	7/16"X20
ADMPMJ-08-05	1/2"X14	1/2"X20
ADMPMJ-08-06	1/2"X14	9/16"X18
ADMPMJ-08-08	1/2"X14	3/4"X16
ADMPMJ-08-10	1/2"X14	7/8"X14
ADMPMJ-08-12	1/2"X14	1.1/16"X12
ADMPMJ-08-16	1/2"X14	1.5/16"X12
ADMPMJ-12-08	3/4"X14	3/4"X16
ADMPMJ-12-10	3/4"X14	7/8"X14
ADMPMJ-12-12	3/4"X14	1.1/16"X12
ADMPMJ-12-16	3/4"X14	1.5/16"X12
ADMPMJ-16-08	1"X11.5	3/4"X16
ADMPMJ-16-10	1"X11.5	7/8"X14
ADMPMJ-16-12	1"X11.5	1.1/16"X12
ADMPMJ-16-16	1"X11.5	1.5/16"X12
ADMPMJ-16-20	1"X11.5	1.5/8"X12
ADMPMJ-20-16	1.1/4"X11.5	1.5/16"X12
ADMPMJ-20-20	1.1/4"X11.5	1.5/8"X12
ADMPMJ-20-24	1.1/4"X11.5	1.7/8"X12
ADMPMJ-24-20	1.1/2"X11.5	1.5/8"X12
ADMPMJ-24-24	1.1/2"X11.5	1.7/8"X12
ADMPMJ-24-32	1.1/2"X11.5	2.1/2"X12
ADMPMJ-32-24	2"X11.5	1.7/8"X12
ADMPMJ-32-32	2"X11.5	2.1/2"X12

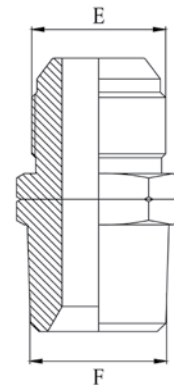

AD45MPMJ

**ADAPTADOR CURVA 45°
MACHO NPT X MACHO JIC 37°**

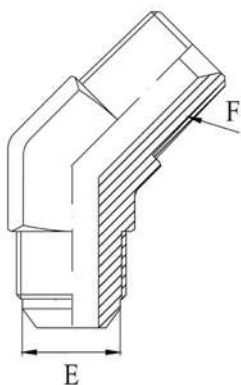

COD. ARAFLEX	ROSCA	
	F	E
AD45MPMJ-02-04	1/8"X27	7/16"X20
AD45MPMJ-04-04	1/4"X18	7/16"X20
AD45MPMJ-04-05	1/4"X18	1/2"X20
AD45MPMJ-04-06	1/4"X18	7/16"X20
AD45MPMJ-06-04	3/8"X18	1/2"X20
AD45MPMJ-06-06	3/8"X18	9/16"X18
AD45MPMJ-06-08	3/8"X18	3/4"X16
AD45MPMJ-08-06	1/2"X14	9/16"X18
AD45MPMJ-08-08	1/2"X14	3/4"X16
AD45MPMJ-08-10	1/2"X14	7/8"X14
AD45MPMJ-12-08	3/4"X14	3/4"X16
AD45MPMJ-12-12	3/4"X14	1.1/16"X12
AD45MPMJ-16-16	1"X11.5	1.5/16"X12
AD45MPMJ-20-20	1.1/4"X11.5	1.5/8"X12
AD45MPMJ-24-24	1.1/2"X11.5	1.7/8"X12

AD90MPMJ
**ADAPTADOR CURVA 90°
MACHO NPT X MACHO JIC 37°**

COD. ARAFLEX	ROSCA	
	F	E
AD90MPMJ-02-04	1/8"X27	7/16"X20
AD90MPMJ-02-06	1/8"X27	9/16"X18
AD90MPMJ-04-04	1/4"X18	7/16"X20
AD90MPMJ-04-05	1/4"X18	1/2"X20
AD90MPMJ-04-06	1/4"X18	9/16"X18
AD90MPMJ-04-08	1/4"X18	3/4"X16
AD90MPMJ-06-04	3/8"X18	7/16"X20
AD90MPMJ-06-05	3/8"X18	1/2"X20
AD90MPMJ-06-06	3/8"X18	9/16"X18
AD90MPMJ-06-08	3/8"X18	3/4"X16
AD90MPMJ-08-06	1/2"X14	9/16"X18
AD90MPMJ-08-08	1/2"X14	3/4"X16
AD90MPMJ-08-10	1/2"X14	7/8"X14
AD90MPMJ-08-12	1/2"X14	1.1/16"X12
AD90MPMJ-12-08	3/4"X14	3/4"X16
AD90MPMJ-12-10	3/4"X14	7/8"X14
AD90MPMJ-12-12	3/4"X14	1.1/16"X12
AD90MPMJ-12-16	3/4"X14	1.5/16"X12
AD90MPMJ-16-12	1"X11.5	1.1/16"X12
AD90MPMJ-16-16	1"X11.5	1.5/16"X12
AD90MPMJ-20-20	1.1/4"X11.5	1.5/8"X12
AD90MPMJ-24-24	1.1/2"X11.5	1.7/8"X12
AD90MPMJ-32-32	2"X11.5	2.1/2"X12

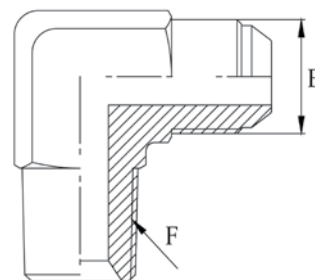

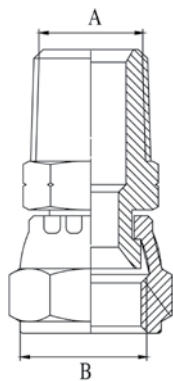
ADAPTADOR RETO MACHO NPT X FÊMEA JIC 37°

COD.ARAFLEX	ROSCA	
	A	B
ADMPFJ-02-04	1/8"X27	7/16"X20
ADMPFJ-02-05	1/8"X27	1/2"X20
ADMPFJ-04-04	1/4"X18	7/16"X20
ADMPFJ-04-05	1/4"X18	1/2"X20
ADMPFJ-04-06	1/4"X18	9/16"X18
ADMPFJ-04-08	1/4"X18	3/4"X16
ADMPFJ-06-06	3/8"X18	9/16"X18
ADMPFJ-06-08	3/8"X18	3/4"X16
ADMPFJ-06-10	3/8"X18	7/8"X14
ADMPFJ-08-06	1/2"X14	9/16"X18
ADMPFJ-08-08	1/2"X14	3/4"X16
ADMPFJ-08-10	1/2"X14	7/8"X14
ADMPFJ-08-12	1/2"X14	1.1/16"X12
ADMPFJ-12-08	3/4"X14	3/4"X16
ADMPFJ-12-10	3/4"X14	7/8"X14
ADMPFJ-12-12	3/4"X14	1.1/16"X12
ADMPFJ-12-16	3/4"X14	1.5/16"X12
ADMPFJ-16-12	1"X11.5	1.1/16"X12
ADMPFJ-16-16	1"X11.5	1.5/16"X12
ADMPFJ-16-20	1"X11.5	1.5/8"X12
ADMPFJ-20-20	1.1/4"X11.5	1.5/8"X12
ADMPFJ-20-24	1.1/4"X11.5	1.7/8"X12
ADMPFJ-24-20	1.1/2"X11.5	1.5/8"X12
ADMPFJ-24-24	1.1/2"X11.5	1.7/8"X12

ADMBFB

ADAPTADOR RETO MACHO BSP X FÊMEA BSP COM O'RING

COD. ARAFLEX	ROSCA	
	E	F
ADMBFB-02-04	1/8"X28	1/4"X19
ADMBFB-02-06	1/8"X28	3/8"X19
ADMBFB-04-02	1/4"X19	1/8"X28
ADMBFB-04-04	1/4"X19	1/4"X19
ADMBFB-04-06	1/4"X19	3/8"X19
ADMBFB-04-08	1/4"X19	1/2"X14
ADMBFB-04-12	1/4"X19	3/4"X14
ADMBFB-06-02	3/8"X19	1/8"X28
ADMBFB-06-04	3/8"X19	1/4"X19
ADMBFB-06-08	3/8"X19	1/2"X14
ADMBFB-06-12	3/8"X19	3/4"X14
ADMBFB-08-02	1/2"X14	1/8"X28
ADMBFB-08-04	1/2"X14	1/4"X19
ADMBFB-08-06	1/2"X14	3/8"X19
ADMBFB-08-08	1/2"X14	1/2"X14
ADMBFB-08-12	1/2"X14	3/4"X14
ADMBFB-08-16	1/2"X14	1"X11
ADMBFB-08-20	1/2"X14	1.1/4"X11
ADMBFB-12-04	3/4"X14	1/4"X19
ADMBFB-12-06	3/4"X14	3/8"X19
ADMBFB-12-08	3/4"X14	1/2"X14
ADMBFB-12-16	3/4"X14	1"X11
ADMBFB-12-20	3/4"X14	1.1/4"X11
ADMBFB-12-24	3/4"X14	1.1/2"X11
ADMBFB-16-04	1"X11	1/4"X19
ADMBFB-16-06	1"X11	3/8"X19
ADMBFB-16-08	1"X11	1/2"X14
ADMBFB-16-12	1"X11	3/4"X14
ADMBFB-16-16	1"X11	1"X11
ADMBFB-16-20	1"X11	1.1/4"X11
ADMBFB-16-24	1"X11	1.1/2"X11
ADMBFB-20-08	1.1/4"X11	1/2"X14
ADMBFB-20-12	1.1/4"X11	3/4"X14
ADMBFB-20-16	1.1/4"X11	1"X11
ADMBFB-20-24	1.1/4"X11	1.1/4"X11
ADMBFB-24-08	1.1/2"X11	1/2"X14
ADMBFB-24-12	1.1/2"X11	3/4"X14
ADMBFB-24-16	1.1/2"X11	1"X11
ADMBFB-24-20	1.1/2"X11	1.1/4"X11
ADMBFB-24-32	1.1/2"X11	2"X11

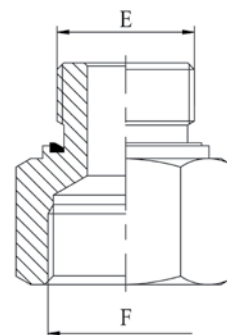

ADMBMB

ADAPTADOR RETO MACHO BSP X MACHO BSP COM O'RING

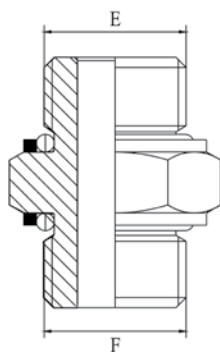

COD. ARAFLEX	ROSCA	
	E	F
ADMBMB-02-02	1/8"X28	1/8"X28
ADMBMB-04-04	1/4"X19	1/4"X19
ADMBMB-06-06	3/8"X19	3/8"X19
ADMBMB-08-08	1/2"X14	1/2"X14
ADMBMB-12-12	3/4"X14	3/4"X14
ADMBMB-16-16	1"X11	1"X11
ADMBMB-20-20	1.1/4"X11	1.1/4"X11
ADMBMB-24-24	1.1/2"X11	1.1/2"X11

ADMBMSP

ADAPTADOR RETO MACHO BSP X MACHO ORFS COM O'RING

COD. ARAFLEX	ROSCA	
	E	F
ADMBMSP-02-04	1/8"X28	9/16"X18
ADMBMSP-04-04	1/4"X19	9/16"X18
ADMBMSP-04-06	1/4"X19	11/16"X16
ADMBMSP-04-10	1/4"X19	1"X14
ADMBMSP-04-12	1/4"X19	1.3/16"X12
ADMBMSP-06-04	3/8"X19	9/16"X18
ADMBMSP-06-06	3/8"X19	11/16"X16
ADMBMSP-06-08	3/8"X19	13/16"X16
ADMBMSP-06-10	3/8"X19	1"X14
ADMBMSP-08-04	1/2"X14	9/16"X18
ADMBMSP-08-08	1/2"X14	13/16"X16
ADMBMSP-08-10	1/2"X14	1"X14
ADMBMSP-08-12	1/2"X14	1.3/16"X12
ADMBMSP-10-10	5/8"X14	1"X14
ADMBMSP-12-06	3/4"X14	11/16"X16
ADMBMSP-12-08	3/4"X14	13/16"X16
ADMBMSP-12-10	3/4"X14	1"X14
ADMBMSP-12-12	3/4"X14	1.3/16"X12
ADMBMSP-12-16	3/4"X14	1.7/16"X12
ADMBMSP-16-10	1"X11	1"X14
ADMBMSP-16-12	1"X11	1.3/16"X12
ADMBMSP-16-16	1"X11	1.7/16"X12
ADMBMSP-16-20	1"X11	1.11/16"X12
ADMBMSP-20-12	1.1/4"X11	1.3/16"X12
ADMBMSP-20-16	1.1/4"X11	1.7/16"X12
ADMBMSP-20-20	1.1/4"X11	1.11/16"X12
ADMBMSP-24-16	1.1/2"X11	1.7/16"X12
ADMBMSP-24-20	1.1/2"X11	1.11/16"X12
ADMBMSP-24-24	1.1/2"X11	2"X12

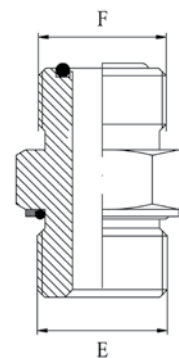

ADMBFSP

ADAPTADOR RETO MACHO BSP X FÊMEA ORFS COM O'RING

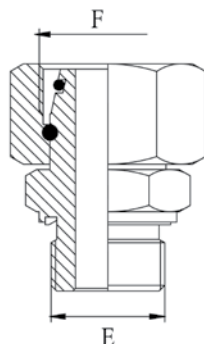

COD. ARAFLEX	ROSCA	
	E	F
ADMBFSP-02-04	1/8"X28	9/16"X18
ADMBFSP-04-04	1"X11	1.7/16"X12
ADMBFSP-04-06	1/4"X19	9/16"X18
ADMBFSP-06-06	1.1/4"X11	1.3/16"X12
ADMBFSP-06-08	1/4"X19	11/16"X16
ADMBFSP-08-08	1.1/4"X11	1.11/16"X12
ADMBFSP-08-10	3/8"X19	11/16"X16
ADMBFSP-12-12	3/8"X19	13/16"X16
ADMBFSP-16-16	1/2"X14	13/16"X16
ADMBFSP-20-12	1.1/2"X11	2"X12
ADMBFSP-20-20	1/2"X14	1"X14
ADMBFSP-24-24	3/4"X14	1.3/16"X12

ADMSPMSP

ADAPTADOR RETO MACHO ORFS X MACHO ORFS SEDE PLANA

COD. ARAFLEX	ROSCA	
	E	F
ADMSPMSP-04-04	9/16"X18	9/16"X18
ADMSPMSP-06-04	11/16"X16	9/16"X18
ADMSPMSP-06-06	11/16"X16	11/16"X16
ADMSPMSP-08-06	13/16"X16	11/16"X16
ADMSPMSP-08-08	13/16"X16	13/16"X16
ADMSPMSP-10-08	1"X14	13/16"X16
ADMSPMSP-10-10	1"X14	1"X14
ADMSPMSP-12-06	1.3/16"X12	11/16"X16
ADMSPMSP-12-08	1.3/16"X12	13/16"X16
ADMSPMSP-12-10	1.3/16"X12	1"X14
ADMSPMSP-12-12	1.3/16"X12	1.3/16"X12
ADMSPMSP-16-12	1.7/16"X12	1.3/16"X12
ADMSPMSP-16-16	1.7/16"X12	1.7/16"X12
ADMSPMSP-20-16	1.11/16"X12	1.7/16"X12
ADMSPMSP-20-20	1.11/16"X12	1.11/16"X12
ADMSPMSP-24-24	2"X12	2"X12

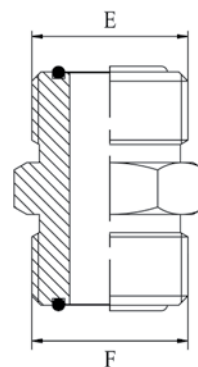

AD90MSPMSP

ADAPTADOR CURVA 90° MACHO ORFS X MACHO ORFS SEDE PLANA

COD. ARAFLEX	ROSCA	
	E	F
AD90MSPMSP-04-04	9/16"X18	9/16"X18
AD90MSPMSP-06-04	11/16"X16	9/16"X18
AD90MSPMSP-06-06	11/16"X16	11/16"X16
AD90MSPMSP-08-06	13/16"X16	11/16"X16
AD90MSPMSP-08-08	13/16"X16	13/16"X16
AD90MSPMSP-10-08	1"X14	13/16"X16
AD90MSPMSP-10-10	1"X14	1"X14
AD90MSPMSP-12-06	1.3/16"X12	11/16"X16
AD90MSPMSP-12-08	1.3/16"X12	13/16"X16
AD90MSPMSP-12-10	1.3/16"X12	1"X14
AD90MSPMSP-12-12	1.3/16"X12	1.3/16"X12
AD90MSPMSP-12-16	1.3/16"X12	1.7/16"X12
AD90MSPMSP-16-10	1.7/16"X12	1"X14
AD90MSPMSP-16-16	1.7/16"X12	1.7/16"X12
AD90MSPMSP-20-16	1.11/16"X12	1.7/16"X12
AD90MSPMSP-20-20	1.11/16"X12	1.11/16"X12
AD90MSPMSP-24-24	2"X12	2"X12

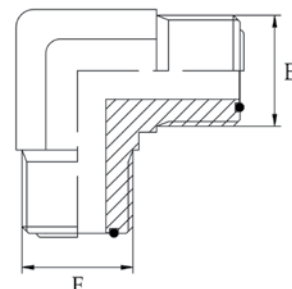

ADMSPMSPL

ADAPTADOR RETO MACHO ORFS X MACHO ORFS PAINEL / LONGO

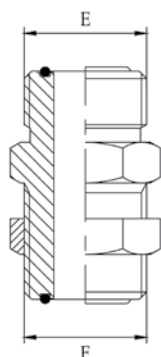

COD. ARAFLEX	ROSCA	
	E	F
ADMSPMSPL-04-04	9/16"X18	9/16"X18
ADMSPMSPL-06-06	11/16"X16	11/16"X16
ADMSPMSPL-08-08	13/16"X16	13/16"X16
ADMSPMSPL-10-10	1"X14	1"X14
ADMSPMSPL-12-12	1.3/16"X12	1.3/16"X12
ADMSPMSPL-16-16	1.7/16"X12	1.7/16"X12
ADMSPMSPL-20-20	1.11/16"X12	1.11/16"X12
ADMSPMSPL-24-24	2"X12	2"X12

AD90MSPMSPL

ADAPTADOR CURVA 90° MACHO ORFS X MACHO ORFS PAINEL / LONGO - COM PORCA ORIENTÁVEL

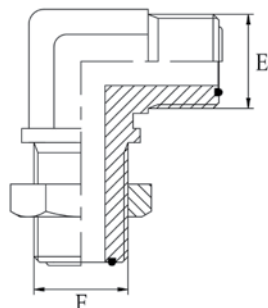

COD. ARAFLEX	ROSCA	
	E	F
AD90MSPMSPL-04-04	9/16"X18	9/16"X18
AD90MSPMSPL-06-06	11/16"X16	11/16"X16
AD90MSPMSPL-08-08	13/16"X16	13/16"X16
AD90MSPMSPL-10-10	1"X14	1"X14
AD90MSPMSPL-12-12	1.3/16"X12	1.3/16"X12
AD90MSPMSPL-16-16	1.7/16"X12	1.7/16"X12
AD90MSPMSPL-20-20	1.11/16"X12	1.11/16"X12
AD90MSPMSPL-24-24	2"X12	2"X12

ADMSPFSP

ADAPTADOR RETO MACHO ORFS X FÊMEA ORFS SEDE PLANA

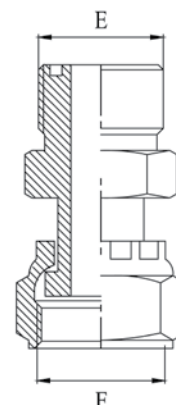

COD. ARAFLEX	ROSCA	
	E	F
ADMSPFSP-04-04	9/16"X18	9/16"X18
ADMSPFSP-04-06	9/16"X18	11/16"X16
ADMSPFSP-04-08	9/16"X18	13/16"X16
ADMSPFSP-06-04	11/16"X16	9/16"X18
ADMSPFSP-06-06	11/16"X16	11/16"X16
ADMSPFSP-06-08	11/16"X16	13/16"X16
ADMSPFSP-06-10	11/16"X16	1"X14
ADMSPFSP-08-06	13/16"X16	11/16"X16
ADMSPFSP-08-08	13/16"X16	13/16"X16
ADMSPFSP-08-10	13/16"X16	1"X14
ADMSPFSP-08-12	13/16"X16	1.3/16"X12
ADMSPFSP-10-08	1"X14	13/16"X16
ADMSPFSP-10-10	1"X14	1"X14
ADMSPFSP-10-12	1"X14	1.3/16"X12
ADMSPFSP-10-16	1"X14	1.7/16"X12
ADMSPFSP-12-08	1.3/16"X12	13/16"X16
ADMSPFSP-12-10	1.3/16"X12	1"X14
ADMSPFSP-12-12	1.3/16"X12	1.3/16"X12
ADMSPFSP-12-16	1.3/16"X12	1.7/16"X12
ADMSPFSP-16-12	1.7/16"X12	1.3/16"X12
ADMSPFSP-16-16	1.7/16"X12	1.7/16"X12
ADMSPFSP-16-20	1.7/16"X12	1.11/16"X12
ADMSPFSP-20-16	1.11/16"X12	1.7/16"X12
ADMSPFSP-20-20	1.11/16"X12	1.11/16"X12

AD45MSPFSP

ADAPTADOR CURVA 45° MACHO ORFS X FÊMEA ORFS SEDE PLANA

COD. ARAFLEX	ROSCA	
	E	F
AD45MSPFSP-04-04	9/16"X18	9/16"X18
AD45MSPFSP-06-06	11/16"X16	11/16"X16
AD45MSPFSP-08-08	13/16"X16	13/16"X16
AD45MSPFSP-10-10	1"X14	1"X14
AD45MSPFSP-12-12	1.3/16"X12	1.3/16"X12
AD45MSPFSP-16-16	1.7/16"X12	1.7/16"X12
AD45MSPFSP-20-20	1.11/16"X12	1.11/16"X12
AD45MSPFSP-24-24	2"X12	2"X12

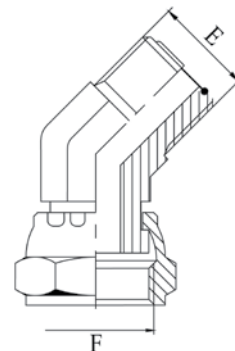

AD90MSPFSP

ADAPTADOR CURVA 90° MACHO ORFS X FÊMEA ORFS SEDE PLANA

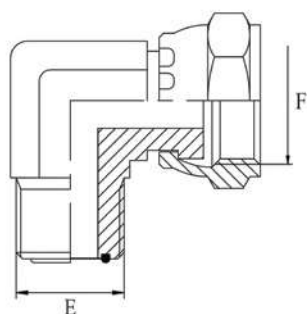

COD. ARAFLEX	ROSCA	
	E	F
AD90MSPFSP-04-04	9/16"X18	9/16"X18
AD90MSPFSP-06-06	11/16"X16	11/16"X16
AD90MSPFSP-08-08	13/16"X16	13/16"X16
AD90MSPFSP-10-10	1"X14	1"X14
AD90MSPFSP-12-12	1.3/16"X12	1.3/16"X12
AD90MSPFSP-16-16	1.7/16"X12	1.7/16"X12
AD90MSPFSP-20-20	1.11/16"X12	1.11/16"X12
AD90MSPFSP-24-24	2"X12	2"X12

ADFSPFSP

ADAPTADOR RETO FÊMEA ORFS X FÊMEA ORFS SEDE PLANA

COD. ARAFLEX	ROSCA	
	E	F
ADFSPFSP-04-04	9/16"X18	9/16"X18
ADFSPFSP-06-06	11/16"X16	11/16"X16
ADFSPFSP-08-08	13/16"X16	13/16"X16
ADFSPFSP-10-10	1"X14	1"X14
ADFSPFSP-12-12	1.3/16"X12	1.3/16"X12
ADFSPFSP-16-16	1.7/16"X12	1.7/16"X12
ADFSPFSP-20-20	1.11/16"X12	1.11/16"X12
ADFSPFSP-24-24	2"X12	2"X12

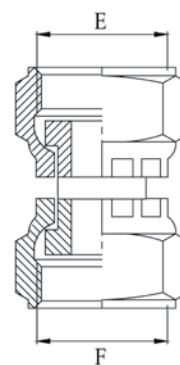

ADMSPMO

ADAPTADOR RETO MACHO ORFS X MACHO UNF COM O'RING

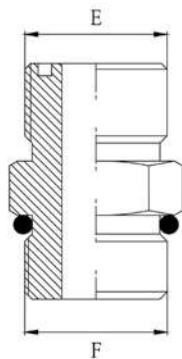

COD. ARAFLEX	ROSCA	
	E	F
ADMSPMO-04-04	9/16"X18	7/16"X2
ADMSPMO-06-06	11/16"X16	9/16"X18
ADMSPMO-06-08	11/16"X16	3/4"X16
ADMSPMO-06-10	11/16"X16	7/8"X14
ADMSPMO-08-06	13/16"X16	9/16"X18
ADMSPMO-08-08	13/16"X16	3/4"X16
ADMSPMO-08-10	13/16"X16	7/8"X14
ADMSPMO-08-12	13/16"X16	1.1/16"X12
ADMSPMO-10-08	1"X14	3/4"X16
ADMSPMO-10-10	1"X14	7/8"X14
ADMSPMO-10-12	1"X14	1.1/16"X12
ADMSPMO-12-10	1.3/16"X12	7/8"X14
ADMSPMO-12-12	1.3/16"X12	1.1/16"X12
ADMSPMO-12-16	1.3/16"X12	1.5/16"X12
ADMSPMO-16-12	1.7/16"X12	1.1/16"X12
ADMSPMO-16-16	1.7/16"X12	1.5/16"X12
ADMSPMO-16-20	1.7/16"X12	1.5/8"X12
ADMSPMO-20-16	1.11/16"X12	1.5/16"X12
ADMSPMO-20-20	1.11/16"X12	1.5/8"X12

AD90MSPMO

ADAPTADOR CURVA 90° MACHO ORFS X MACHO UNF ORIENTÁVEL COM O'RING

COD. ARAFLEX	ROSCA	
	E	F
AD90MSPMO-04-04	9/16"X18	7/16"X20
AD90MSPMO-04-05	9/16"X18	1/2"X20
AD90MSPMO-04-06	9/16"X18	9/16"X18
AD90MSPMO-04-08	9/16"X18	3/4"X16
AD90MSPMO-06-04	11/16"X16	7/16"X20
AD90MSPMO-06-06	11/16"X16	9/16"X18
AD90MSPMO-06-08	11/16"X16	3/4"X16
AD90MSPMO-06-10	11/16"X16	7/8"X14
AD90MSPMO-08-06	13/16"X16	9/16"X18
AD90MSPMO-08-08	13/16"X16	3/4"X16
AD90MSPMO-08-10	13/16"X16	7/8"X14
AD90MSPMO-08-12	13/16"X16	1.1/16"X12
AD90MSPMO-10-08	1"X14	3/4"X16
AD90MSPMO-10-10	1"X14	7/8"X14
AD90MSPMO-10-12	1"X14	1.1/16"X12
AD90MSPMO-12-10	1.3/16"X12	7/8"X14
AD90MSPMO-12-12	1.3/16"X12	1.1/16"X12
AD90MSPMO-16-12	1.7/16"X12	1.1/16"X12
AD90MSPMO-16-16	1.7/16"X12	1.5/16"X12

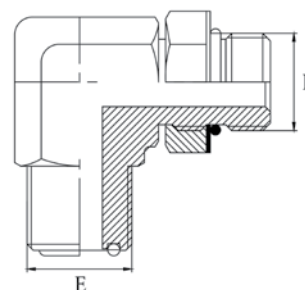

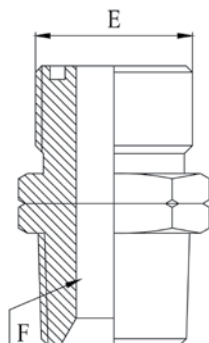
ADMSPMP**ADAPTADOR RETO
MACHO ORFS X MACHO NPT**

COD. ARAFLEX	ROSCA	
	E	F
ADMSPMP-04-02	9/16"X18	1/8"X27
ADMSPMP-04-04	9/16"X18	1/4"X18
ADMSPMP-04-06	11/16"X16	3/8"X18
ADMSPMP-04-06	9/16"X18	3/8"X18
ADMSPMP-06-04	11/16"X16	1/4"X18
ADMSPMP-06-06	11/16"X16	3/8"X18
ADMSPMP-06-08	11/16"X16	1/2"X14
ADMSPMP-08-04	13/16"X16	1/4"X18
ADMSPMP-08-06	13/16"X16	3/8"X18
ADMSPMP-08-08	13/16"X16	1/2"X14
ADMSPMP-08-12	13/16"X16	3/4"X14
ADMSPMP-10-08	1"X14	1/2"X14
ADMSPMP-10-12	1"X14	3/4"X14
ADMSPMP-12-08	1.3/16"X12	1/2"X14
ADMSPMP-12-12	1.3/16"X12	3/4"X14
ADMSPMP-12-16	1.3/16"X12	1"X11.5
ADMSPMP-16-12	1.7/16"X12	3/4"X14
ADMSPMP-16-16	1.7/16"X12	1"X11.5
ADMSPMP-16-20	1.7/16"X12	1.1/4"X11.5
ADMSPMP-20-16	1.11/16"X12	1"X11.5
ADMSPMP-20-20	1.11/16"X12	1.1/4"X11.5
ADMSPMP-20-24	1.11/16"X12	1.1/2"X11.5

ADMSPMB

ADAPTADOR RETO MACHO ORFS X MACHO BSP COM O'RING

COD. ARAFLEX	ROSCA	
	E	F
ADMSPMB-04-02	9/16"X18	1/8"X28
ADMSPMB-04-04	9/16"X18	1/4"X19
ADMSPMB-04-06	9/16"X18	3/8"X19
ADMSPMB-06-04	11/16"X16	1/4"X19
ADMSPMB-06-06	11/16"X16	3/8"X19
ADMSPMB-06-08	11/16"X16	1/2"X14
ADMSPMB-08-06	13/16"X16	3/8"X19
ADMSPMB-08-08	13/16"X16	1/2"X14
ADMSPMB-08-12	13/16"X16	3/4"X14
ADMSPMB-10-08	1"X14	1/2"X14
ADMSPMB-10-12	1"X14	3/4"X14
ADMSPMB-12-08	1.3/16"X12	1/2"X14
ADMSPMB-12-12	1.3/16"X12	3/4"X14
ADMSPMB-12-16	1.3/16"X12	1"X11
ADMSPMB-16-12	1.7/16"X12	3/4"X14
ADMSPMB-16-16	1.7/16"X12	1"X11
ADMSPMB-20-16	1.11/16"X12	1"X11
ADMSPMB-20-20	1.11/16"X12	1.1/4"X11

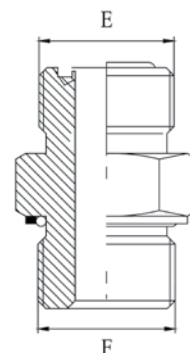

ADMSPMM

ADAPTADOR RETO MACHO ORFS X MACHO MÉTRICO

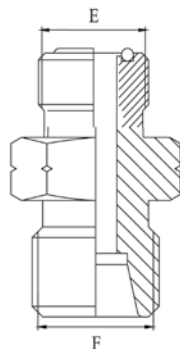

COD. ARAFLEX	ROSCA	
	E	F
ADMSPMM-04-10	9/16"X18	M10X1.5
ADMSPMM-04-12	9/16"X18	M12X1.5
ADMSPMM-04-14	9/16"X18	M14X1.5
ADMSPMM-06-12	11/16"X16	M12X1.5
ADMSPMM-06-14	11/16"X16	M14X1.5
ADMSPMM-06-16	11/16"X16	M16X1.5
ADMSPMM-06-18	11/16"X16	M18X1.5
ADMSPMM-08-14	13/16"X16	M14X1.5
ADMSPMM-08-16	13/16"X16	M16X1.5
ADMSPMM-08-18	13/16"X16	M18X1.5
ADMSPMM-08-22	13/16"X16	M22X1.5
ADMSPMM-10-18	1"X14	M18X1.5
ADMSPMM-10-22	1"X14	M22X1.5
ADMSPMM-10-27	1"X14	M27X2
ADMSPMM-12-22	1.3/16"X12	M22X1.5
ADMSPMM-12-27	1.3/16"X12	M27X2
ADMSPMM-12-33	1.3/16"X12	M33X2
ADMSPMM-16-27	1.7/16"X12	M27X2
ADMSPMM-16-33	1.7/16"X12	M33X2
ADMSPMM-16-42	1.7/16"X12	M42X2
ADMSPMM-20-33	1.11/16"X12	M33X2
ADMSPMM-20-42	1.11/16"X12	M42X2
ADMSPMM-20-48	1.11/16"X12	M48X2
ADMSPMM-24-48	2"X12	M48X2

ADTEEMJ

ADAPTADOR TEE MACHO JIC 37°

COD. ARAFLEX	ROSCA		
	E	F	G
ADTEEMJ-04	7/16"X20	7/16"X20	7/16"X20
ADTEEMJ-04-06-04	7/16"X20	9/16"X18	7/16"X20
ADTEEMJ-05	1/2"X20	1/2"X20	1/2"X20
ADTEEMJ-06	9/16"X18	9/16"X18	9/16"X18
ADTEEMJ-06-04-06	9/16"X18	7/16"X20	9/16"X18
ADTEEMJ-08	3/4"X16	3/4"X16	3/4"X16
ADTEEMJ-08-06-08	3/4"X16	9/16"X18	3/4"X16
ADTEEMJ-10	7/8"X14	7/8"X14	7/8"X14
ADTEEMJ-12	1.1/16"X12	1.1/16"X12	1.1/16"X12
ADTEEMJ-16	1.5/16"X12	1.5/16"X12	1.5/16"X12
ADTEEMJ-16-12-16	1.5/16"X12	1.1/16"X12	1.5/16"X12
ADTEEMJ-20	1.5/8"X12	1.5/8"X12	1.5/8"X12

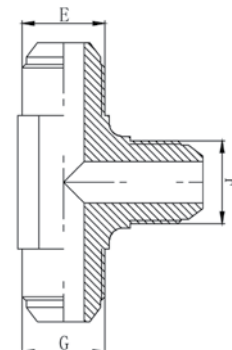

ADTEEMJFJC

ADAPTADOR TEE MACHO JIC 37° X FÊMEA JIC 37° CENTRAL

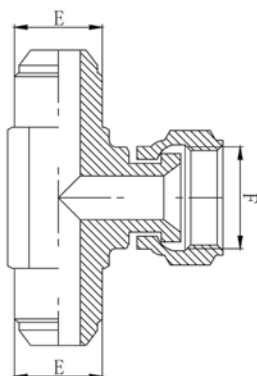

COD. ARAFLEX	ROSCA		
	E	F	G
ADTEEMJFJC-04	7/16"X20	7/16"X20	7/16"X20
ADTEEMJFJC-05	1/2"X20	1/2"X20	1/2"X20
ADTEEMJFJC-06	9/16"X18	9/16"X18	9/16"X18
ADTEEMJFJC-08	3/4"X16	3/4"X16	3/4"X16
ADTEEMJFJC-10	7/8"X14	7/8"X14	7/8"X14
ADTEEMJFJC-12	1.1/16"X12	1.1/16"X12	1.1/16"X12
ADTEEMJFJC-16	1.5/16"X12	1.5/16"X12	1.5/16"X12
ADTEEMJFJC-20	1.5/8"X12	1.5/8"X12	1.5/8"X12

ADTEEMJFJL

ADAPTADOR TEE MACHO JIC 37° X FÊMEA JIC 37° LATERAL

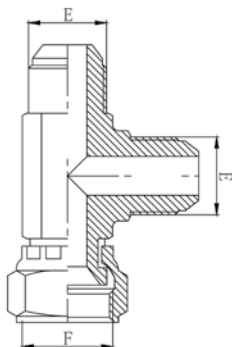

COD. ARAFLEX	ROSCA	
	E	F
ADTEEMJFJL-04	7/16"X20	7/16"X20
ADTEEMJFJL-05	1/2"X20	1/2"X20
ADTEEMJFJL-06	9/16"X18	9/16"X18
ADTEEMJFJL-08	3/4"X16	3/4"X16
ADTEEMJFJL-10	7/8"X14	7/8"X14
ADTEEMJFJL-12	1.1/16"X12	1.1/16"X12
ADTEEMJFJL-16	1.5/16"X12	1.5/16"X12
ADTEEMJFJL-20	1.5/8"X12	1.5/8"X12

ADTEEMJMPC

ADAPTADOR TEE MACHO JIC 37° X MACHO NPT CENTRAL

COD. ARAFLEX	ROSCA		
	E	F	E
ADTEEMJMPC-04	7/16"X20	1/4"X18	7/16"X20
ADTEEMJMPC-04-02-04	7/16"X20	1/8"X27	7/16"X20
ADTEEMJMPC-05-02-05	1/2"X20	1/8"X27	1/2"X20
ADTEEMJMPC-05-04-05	1/2"X20	1/4"X18	1/2"X20
ADTEEMJMPC-06	9/16"X18	3/8"X18	9/16"X18
ADTEEMJMPC-06-04-06	9/16"X18	1/4"X18	9/16"X18
ADTEEMJMPC-08	3/4"X16	1/2"X14	3/4"X16
ADTEEMJMPC-08-06-08	3/4"X16	3/8"X18	3/4"X16
ADTEEMJMPC-10-08-10	7/8"X14	1/2"X14	7/8"X14
ADTEEMJMPC-10-12-10	7/8"X14	3/4"X14	7/8"X14
ADTEEMJMPC-12	1.1/16"X12	3/4"X14	1.1/16"X12
ADTEEMJMPC-12-16-20	1.1/16"X12	1"X11.5	1.1/16"X12
ADTEEMJMPC-16	1.5/16"X12	1"X11.5	1.5/16"X12
ADTEEMJMPC-20	1.5/8"X12	1.1/4"X11.5	1.5/8"X12

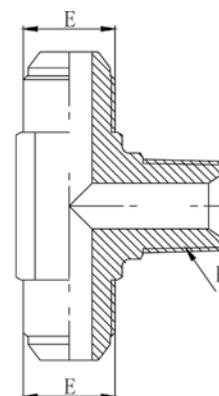

ADTEEMJMPL

ADAPTADOR TEE MACHO JIC 37° X MACHO NPT LATERAL

COD. ARAFLEX	ROSCA	
	E	F
ADTEEMJMPL-04	7/16"X20	1/4"X18
ADTEEMJMPL-04-04-02	7/16"X20	1/8"X27
ADTEEMJMPL-05-05-02	1/2"X20	1/8"X27
ADTEEMJMPL-05-05-04	1/2"X20	1/4"X18
ADTEEMJMPL-06	9/16"X18	3/8"X18
ADTEEMJMPL-06-06-04	9/16"X18	1/4"X18
ADTEEMJMPL-08	3/4"X16	1/2"X14
ADTEEMJMPL-08-08-06	3/4"X16	3/8"X18
ADTEEMJMPL-10-10-08	7/8"X14	1/2"X14
ADTEEMJMPL-10-10-12	7/8"X14	3/4"X14
ADTEEMJMPL-12	1.1/16"X12	3/4"X14
ADTEEMJMPL-16	1.5/16"X12	1"X11.5
ADTEEMJMPL-20	1.5/8"X12	1.1/4"X11.5

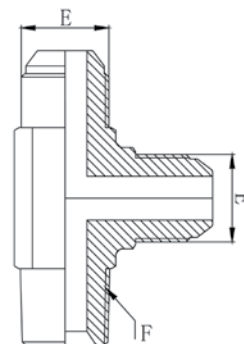

ADTEEMJFFC

ADAPTADOR TEE MACHO JIC 37° X FÊMEA FIXA CENTRAL

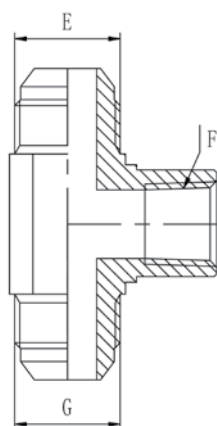

COD. ARAFLEX	ROSCA		
	E	F	G
ADTEEMJFFC-04-02-04	7/16"X20	1/8"X18	7/16"X20
ADTEEMJFFC-04-04-04	7/16"X20	1/4"X18	7/16"X20
ADTEEMJFFC-05-02-05	1/2"X20	1/8"X27	1/2"X20
ADTEEMJFFC-05-04-05	1/2"X20	1/4"X18	1/2"X20
ADTEEMJFFC-06-02-06	9/16"X18	1/8"X18	9/16"X18
ADTEEMJFFC-06-04-06	9/16"X18	1/4"X18	9/16"X18
ADTEEMJFFC-06-06-06	9/16"X18	3/8"X18	9/16"X18
ADTEEMJFFC-08-04-08	3/4"X16	1/4"X18	3/4"X16
ADTEEMJFFC-08-06-08	3/4"X16	3/8"X18	3/4"X16
ADTEEMJFFC-08-08-08	3/4"X16	1/2"X14	3/4"X16
ADTEEMJFFC-10-08-10	7/8"X14	1/2"X14	7/8"X14
ADTEEMJFFC-12-12-12	1.1/16"X12	3/4"X14	1.1/16"X12
ADTEEMJFFC-16-16-16	1.5/16"X12	1"X11.5	1.5/16"X12
ADTEEMJFFC-20-20-20	1.5/8"X12	1.1/4"X11.5	1.5/8"X12
ADTEEMJFFC-24-24-24	1.7/8"X12	1.1/2"X11.5	1.7/8"X12

ADTEEMJFFL

ADAPTADOR TEE MACHO JIC 37° X FÊMEA FIXA LATERAL

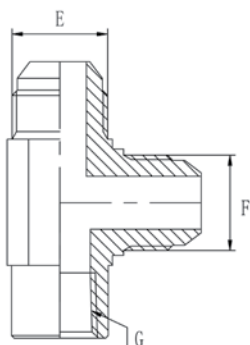

COD. ARAFLEX	ROSCA	
	E	G
ADTEEMJFFL-04-04-02	7/16"X20	1/8"X18
ADTEEMJFFL-04-04-04	7/16"X20	1/4"X18
ADTEEMJFFL-04-04-06	7/16"X20	3/8"X18
ADTEEMJFFL-05-05-02	1/2"X20	1/8"X18
ADTEEMJFFL-05-05-04	1/2"X20	1/4"X18
ADTEEMJFFL-06-06-02	9/16"X18	1/8"X18
ADTEEMJFFL-06-06-04	9/16"X18	1/4"X18
ADTEEMJFFL-06-06-06	9/16"X18	3/8"X18
ADTEEMJFFL-06-06-08	9/16"X18	1/2"X14
ADTEEMJFFL-08-08-04	3/4"X16	1/4"X18
ADTEEMJFFL-08-08-06	3/4"X16	3/8"X18
ADTEEMJFFL-08-08-08	3/4"X16	1/2"X14
ADTEEMJFFL-10-10-08	7/8"X14	1/2"X14
ADTEEMJFFL-12-12-08	1.1/16"X12	1/2"X14
ADTEEMJFFL-12-12-12	1.1/16"X12	3/4"X14
ADTEEMJFFL-16-16-16	1.5/16"X12	1"X11.5
ADTEEMJFFL-20-20-20	1.5/8"X12	1.1/4"X11.5
ADTEEMJFFL-24-24-24	1.7/8"X12	1.1/2"X11.5

ADTEEMJMOC

ADAPTADOR TEE

MACHO JIC 37° X MACHO UNF CENTRAL ORIENTÁVEL

COD. ARAFLEX	ROSCA		
	E	F	G
ADTEEMJMOC-04-04-04	7/16"X20	7/16"X20	7/16"X20
ADTEEMJMOC-04-05-04	7/16"X20	1/2"X20	7/16"X20
ADTEEMJMOC-04-06-04	7/16"X20	9/16"X18	7/16"X20
ADTEEMJMOC-05-05-05	1/2"X20	1/2"X20	1/2"X20
ADTEEMJMOC-06-06-06	9/16"X18	9/16"X18	9/16"X18
ADTEEMJMOC-06-08-06	9/16"X18	3/4"X16	9/16"X18
ADTEEMJMOC-08-08-08	3/4"X16	3/4"X16	3/4"X16
ADTEEMJMOC-08-10-08	3/4"X16	7/8"X14	3/4"X16
ADTEEMJMOC-08-12-08	3/4"X16	1.1/16"X12	3/4"X16
ADTEEMJMOC-10-08-10	7/8"X14	3/4"X16	7/8"X14
ADTEEMJMOC-10-10-10	7/8"X14	7/8"X14	7/8"X14
ADTEEMJMOC-10-12-10	7/8"X14	1.1/16"X12	7/8"X14
ADTEEMJMOC-12-08-12	1.1/16"X12	3/4"X16	1.1/16"X12
ADTEEMJMOC-12-10-12	1.1/16"X12	7/8"X14	1.1/16"X12
ADTEEMJMOC-12-12-12	1.1/16"X12	1.1/16"X12	1.1/16"X12
ADTEEMJMOC-12-16-12	1.1/16"X12	1.5/16"X12	1.1/16"X12
ADTEEMJMOC-16-12-16	1.5/16"X12	1.1/16"X12	1.5/16"X12
ADTEEMJMOC-16-16-16	1.5/16"X12	1.5/16"X12	1.5/16"X12
ADTEEMJMOC-16-20-16	1.5/16"X12	1.5/8"X12	1.5/16"X12
ADTEEMJMOC-20-20-20	1.5/8"X12	1.5/8"X12	1.5/8"X12
ADTEEMJMOC-24-24-24	1.7/8"X12	1.7/8"X12	1.7/8"X12

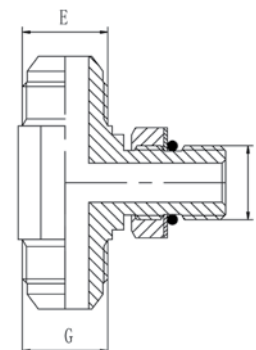

ADTEEMJMOL

ADAPTADOR TEE MACHO JIC 37° X MACHO UNF LATERAL ORIENTÁVEL

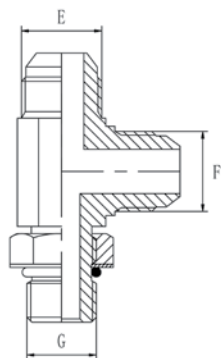

COD. ARAFLEX	ROSCA	
	E	G
ADTEEMJMOL-04-04-04	7/16"X20	7/16"X20
ADTEEMJMOL-04-04-05	7/16"X20	1/2"X20
ADTEEMJMOL-04-04-06	7/16"X20	9/16"X18
ADTEEMJMOL-05-05-05	1/2"X20	1/2"X20
ADTEEMJMOL-06-06-06	9/16"X18	9/16"X18
ADTEEMJMOL-06-06-08	9/16"X18	3/4"X16
ADTEEMJMOL-08-08-06	3/4"X16	9/16"X18
ADTEEMJMOL-08-08-08	3/4"X16	3/4"X16
ADTEEMJMOL-08-08-10	3/4"X16	7/8"X14
ADTEEMJMOL-08-08-12	3/4"X16	1.1/16"X12
ADTEEMJMOL-10-10-08	7/8"X14	3/4"X16
ADTEEMJMOL-10-10-10	7/8"X14	7/8"X14
ADTEEMJMOL-10-10-12	7/8"X14	1.1/16"X12
ADTEEMJMOL-12-12-08	1.1/16"X12	3/4"X16
ADTEEMJMOL-12-12-10	1.1/16"X12	7/8"X14
ADTEEMJMOL-12-12-12	1.1/16"X12	1.1/16"X12
ADTEEMJMOL-12-12-16	1.1/16"X12	1.5/16"X12
ADTEEMJMOL-16-16-12	1.5/16"X12	1.1/16"X12
ADTEEMJMOL-16-16-16	1.5/16"X12	1.5/16"X12
ADTEEMJMOL-16-16-20	1.5/16"X12	1.5/8"X12
ADTEEMJMOL-20-20-20	1.5/8"X12	1.5/8"X12
ADTEEMJMOL-24-24-24	1.7/8"X12	1.7/8"X12

ADTEEMP

ADAPTADOR TEE MACHO NPT

COD. ARAFLEX	ROSCA
ADTEEMP-02	1/8"X27
ADTEEMP-04	1/4"X18
ADTEEMP-06	3/8"X18
ADTEEMP-08	1/2"X14
ADTEEMP-12	3/4"X14
ADTEEMP-16	1"X11.5
ADTEEMP-20	1.1/4"X11.5

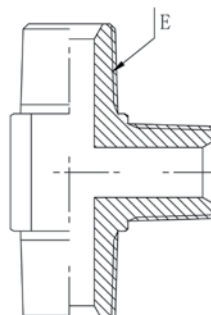

ADTEEFF

ADAPTADOR TEE FÊMEA FIXA NPT

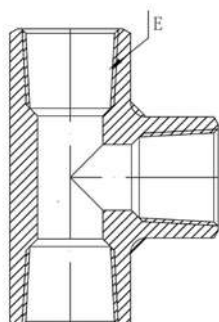

COD.ARAFLEX	ROSCA
ADTEEFF-02	1/8"X27
ADTEEFF-04	1/4"X18
ADTEEFF-06	3/8"X18
ADTEEFF-08	1/2"X14
ADTEEFF-12	3/4"X14
ADTEEFF-16	1"X11.5
ADTEEFF-20	1.1/4"X11.5
ADTEEFF-24	1.1/2"X11.5
ADTEEFF-32	2"X11.5

ADTEEMSP

ADAPTADOR TEE MACHO ORFS

COD. ARAFLEX	ROSCA
ADTEEMSP-04-04	9/16"X18
ADTEEMSP-06-06	11/16"X16
ADTEEMSP-08-08	13/16"X16
ADTEEMSP-10-10	1"X14
ADTEEMSP-12-12	1.3/16"X12
ADTEEMSP-16-16	1.7/16"X12
ADTEEMSP-20-20	1.11/16"X12
ADTEEMSP-24-24	2"X12

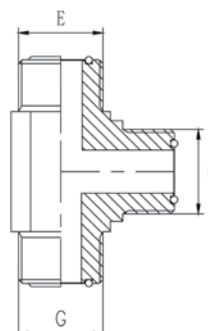

ADTEEMSPMOC

ADAPTADOR TEEMACHO ORFS X MACHO UNF CENTRAL ORIENTÁVEL

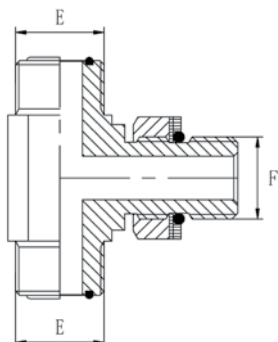

COD. ARAFLEX	RODCA		E
	E	F	
ADTEEMSPMOC-04-04-04	9/16"X18	7/16"X20	9/16"X18
ADTEEMSPMOC-04-05-04	9/16"X18	1/2"X20	9/16"X18
ADTEEMSPMOC-04-06-04	9/16"X18	9/16"X18	9/16"X18
ADTEEMSPMOC-04-08-04	9/16"X18	3/4"X16	9/16"X18
ADTEEMSPMOC-06-04-06	11/16"X16	7/16"X20	11/16"X16
ADTEEMSPMOC-06-06-06	11/16"X16	9/16"X18	11/16"X16
ADTEEMSPMOC-06-08-06	11/16"X16	3/4"X16	11/16"X16
ADTEEMSPMOC-06-10-06	11/16"X16	7/8"X14	11/16"X16
ADTEEMSPMOC-06-12-06	11/16"X16	1.1/16"X12	11/16"X16
ADTEEMSPMOC-08-06-08	13/16"X16	1.1/16"X12	13/16"X16
ADTEEMSPMOC-08-08-08	13/16"X16	3/4"X16	13/16"X16
ADTEEMSPMOC-08-10-08	13/16"X16	7/8"X14	13/16"X16
ADTEEMSPMOC-08-12-08	13/16"X16	1.1/16"X12	13/16"X16
ADTEEMSPMOC-10-08-10	1"X14	3/4"X16	1"X14
ADTEEMSPMOC-10-10-10	1"X14	7/8"X14	1"X14
ADTEEMSPMOC-10-12-10	1"X14	1.1/16"X12	1"X14
ADTEEMSPMOC-12-08-12	1.3/16"X12	3/4"X16	1.3/16"X12
ADTEEMSPMOC-12-10-12	1.3/16"X12	7/8"X14	1.3/16"X12
ADTEEMSPMOC-12-12-12	1.3/16"X12	1.1/16"X12	1.3/16"X12
ADTEEMSPMOC-12-16-12	1.3/16"X12	1.5/16"X12	1.3/16"X12
ADTEEMSPMOC-16-12-16	1.7/16"X12	1.1/16"X12	1.7/16"X12
ADTEEMSPMOC-16-16-16	1.7/16"X12	1.5/16"X12	1.7/16"X12
ADTEEMSPMOC-16-20-16	1.7/16"X12	1.5/8"X12	1.7/16"X12
ADTEEMSPMOC-20-16-20	1.11/16"X12	1.5/16"X12	1.11/16"X12
ADTEEMSPMOC-20-20-20	1.11/16"X12	1.5/8"X12	1.11/16"X12
ADTEEMSPMOC-20-24-20	1.11/16"X12	1.7/8"X12	1.11/16"X12
ADTEEMSPMOC-24-20-24	2"X12	1.5/8"X12	2"X12
ADTEEMSPMOC-24-24-24	2"X12	1.7/8"X12	2"X12

ADTEEMSPMBC

ADAPTADOR TEE MACHO ORFS X MACHO BSP CENTRAL ORIENTÁVEL

COD.ARAFLEX	RODCA		E
	E	F	
ADTEEMSPMBC-04-02-04	9/16"X18	1/8"X28	9/16"X18
ADTEEMSPMBC-04-04-04	9/16"X18	1/4"X19	9/16"X18
ADTEEMSPMBC-04-06-04	9/16"X18	3/8"X19	9/16"X18
ADTEEMSPMBC-06-04-06	11/16"X16	1/4"X19	11/16"X16
ADTEEMSPMBC-06-06-06	11/16"X16	3/8"X19	11/16"X16
ADTEEMSPMBC-06-08-06	11/16"X16	1/2"X14	11/16"X16
ADTEEMSPMBC-08-04-08	13/16"X16	1/4"X19	13/16"X16
ADTEEMSPMBC-08-06-08	13/16"X16	3/8"X19	13/16"X16
ADTEEMSPMBC-08-08-08	13/16"X16	1/2"X14	13/16"X16
ADTEEMSPMBC-08-12-08	13/16"X16	3/4"X14	13/16"X16
ADTEEMSPMBC-10-04-10	1"X14	1/4"X19	1"X14
ADTEEMSPMBC-10-06-10	1"X14	3/8"X19	1"X14
ADTEEMSPMBC-10-08-10	1"X14	1/2"X14	1"X14
ADTEEMSPMBC-10-12-10	1"X14	3/4"X14	1"X14
ADTEEMSPMBC-10-16-10	1"X14	1"X11	1"X14
ADTEEMSPMBC-12-04-12	1.3/16"X12	1/4"X19	1.3/16"X12
ADTEEMSPMBC-12-08-12	1.3/16"X12	1/2"X14	1.3/16"X12
ADTEEMSPMBC-12-12-12	1.3/16"X12	3/4"X14	1.3/16"X12
ADTEEMSPMBC-12-16-12	1.3/16"X12	1"X11	1.3/16"X12
ADTEEMSPMBC-16-04-16	1.7/16"X12	1/4"X19	1.7/16"X12
ADTEEMSPMBC-16-12-16	1.7/16"X12	3/4"X14	1.7/16"X12
ADTEEMSPMBC-16-16-16	1.7/16"X12	1"X11	1.7/16"X12
ADTEEMSPMBC-16-20-16	1.7/16"X12	1.1/4"X11	1.7/16"X12
ADTEEMSPMBC-20-16-20	1.11/16"X12	1"X11	1.11/16"X12
ADTEEMSPMBC-20-20-20	1.11/16"X12	1.1/4"X11	1.11/16"X12
ADTEEMSPMBC-20-24-20	1.11/16"X12	1.1/2"X11	1.11/16"X12
ADTEEMSPMBC-24-24-24	2"X12	1.1/2"X11	2"X12

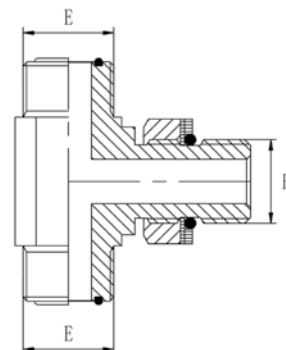

ADMJ

TAMPÃO MACHO JIC 37° SEXTAVADO EXTERNO

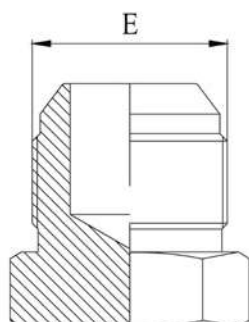

COD. ARAFLEX	ROSCA E
ADMJ-04	7/16"X20
ADMJ-05	1/2"X20
ADMJ-06	9/16"X18
ADMJ-08	3/4"X16
ADMJ-10	7/8"X14
ADMJ-12	1.1/16"X12
ADMJ-16	1.5/16"X12
ADMJ-20	1.5/8"X12
ADMJ-24	1.7/8"X12
ADMJ-32	2.1/2"X12

ADFJ

TAMPÃO FÊMEA JIC 37° SEXTAVADO EXTERNO

COD. ARAFLEX	ROSCA E
ADFJ-04	7/16"X20
ADFJ-05	1/2"X20
ADFJ-06	9/16"X18
ADFJ-08	3/4"X16
ADFJ-10	7/8"X14
ADFJ-12	1.1/16"X12
ADFJ-16	1.5/16"X12

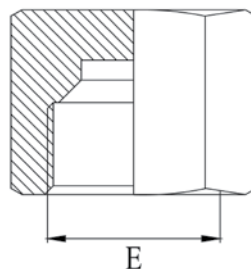

ADMB

TAMPÃO MACHO BSP SEXTAVADO EXTERNO

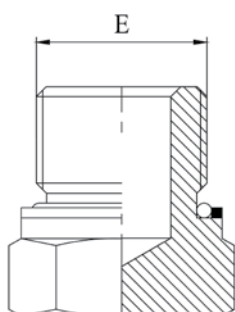

COD. ARAFLEX	ROSCA E
ADMB-04	1/4"X19
ADMB-06	3/8"X19
ADMB-08	1/2"X14
ADMB-12	3/4"X14
ADMB-16	1"X11

ADMBSI

TAMPÃO MACHO BSP SEXTAVADO INTERNO

COD. ARAFLEX	ROSCA E
ADMBSI-02	1/8"X28
ADMBSI-04	1/4"X19
ADMBSI-06	3/8"X19
ADMBSI-08	1/2"X14
ADMBSI-12	3/4"X14
ADMBSI-16	1"X11
ADMBSI-20	1.1/4"X11
ADMBSI-24	1.1/2"X11

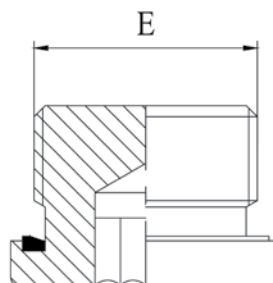

ADMSP

TAMPÃO MACHO SEDE PLANA (ORFS) SEXTAVADO EXTERNO

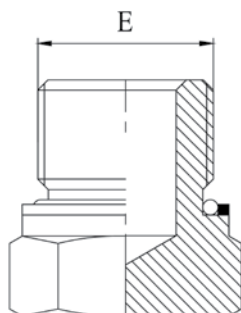

COD. ARAFLEX	ROSCA E
ADMSP-04	9/16"X18
ADMSP-06	11/16"X16
ADMSP-08	13/16"X16
ADMSP-10	1"X14
ADMSP-12	1.3/16"X12
ADMSP-16	1.7/16"X12
ADMSP-20	1.11/16"X12

ADFSP

TAMPÃO FÊMEA SEDE PLANA (ORFS) SEXTAVADO EXTERNO

COD. ARAFLEX	ROSCA E
ADFSP-04	9/16"X18
ADFSP-06	11/16"X16
ADFSP-08	13/16"X16
ADFSP-10	1"X14
ADFSP-12	1.3/16"X12
ADFSP-16	1.7/16"X12
ADFSP-20	1.11/16"X12

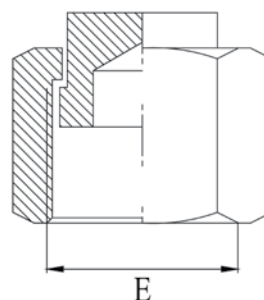

ADMP

TAMPÃO MACHO NPT SEXTAVADO EXTERNO

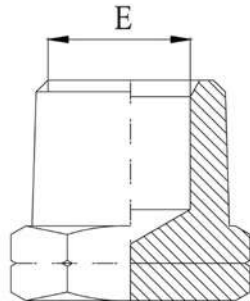

COD. ARAFLEX	ROSCA E
ADMP-02	1/8"X27
ADMP-04	1/4"X18
ADMP-06	3/8"X18
ADMP-08	1/2"X14
ADMP-12	3/4"X14
ADMP-16	1"X11.5
ADMP-20	1.1/4"X11.5
ADMP-24	1.1/2"X11.5
ADMP-32	2"X11.5

ADFF

TAMPÃO FÊMEA NPT SEXTAVADO EXTERNO

COD. ARAFLEX	ROSCA E
ADFF-02	1/8"X27
ADFF-04	1/4"X18
ADFF-06	3/8"X18
ADFF-08	1/2"X14
ADFF-12	3/4"X14
ADFF-16	1"X11.5
ADFF-20	1.1/4"X11.5
ADFF-24	1.1/2"X11.5
ADFF-32	2"X11.5

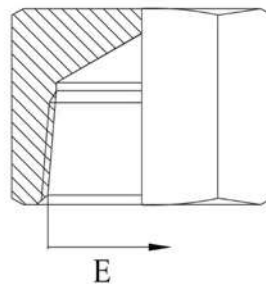

ADMOSE

TAMPÃO MACHO O`RING UNF SEXTAVADO EXTERNO

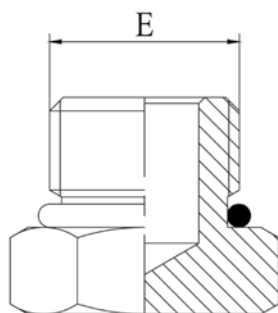

COD. ARAFLEX	ROSCA E
ADMOSE-04	7/16"X20
ADMOSE-05	1/2"X20
ADMOSE-06	9/16"X18
ADMOSE-08	3/4"X16
ADMOSE-10	7/8"X14
ADMOSE-12	1.1/16"X12
ADMOSE-14	1.3/16"X12
ADMOSE-16	1.5/16"X12
ADMOSE-20	1.5/8"X12
ADMOSE-24	1.7/8"X12
ADMOSE-32	2.1/2"X12

ADMOSI

TAMPÃO MACHO O`RING UNF SEXTAVADO INTERNO

COD. ARAFLEX	ROSCA E
ADMOSI-04	7/16"X20
ADMOSI-05	1/2"X20
ADMOSI-06	9/16"X18
ADMOSI-08	3/4"X16
ADMOSI-10	7/8"X14
ADMOSI-12	1.1/16"X12
ADMOSI-14	1.3/16"X12
ADMOSI-16	1.5/16"X12
ADMOSI-20	1.5/8"X12

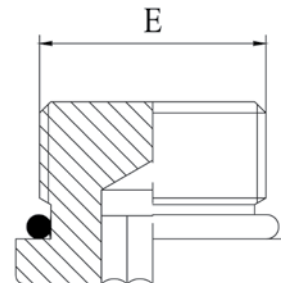

ADMMSI

TAMPÃO MACHO MÉTRICO SEXTAVADO INTERNO

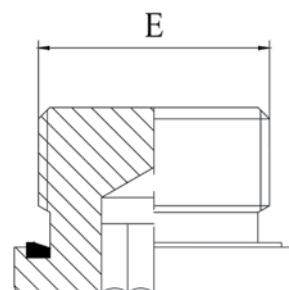

COD. ARAFLEX	ROSCA E
ADMMSI-10	10X1
ADMMSI-12	12X1.5
ADMMSI-14	14X1.5
ADMMSI-16	16X1.5
ADMMSI-18	18X1.5
ADMMSI-20	20X1.5
ADMMSI-22	22X1.5
ADMMSI-26	26X1.5
ADMMSI-27	27X2
ADMMSI-33	33X2
ADMMSI-42	42X2
ADMMSI-48	48X2

ADT

TAMPÃO PARA TUBO

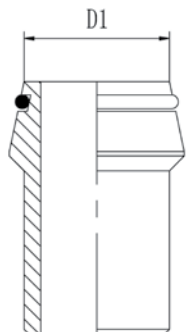

COD. ARAFLEX	TUBO D1
ADT-06	6
ADT-08	8
ADT-10	10
ADT-12	12
ADT-14	14
ADT-15	15
ADT-16	16
ADT-18	18
ADT-20	20
ADT-22	22
ADT-25	25
ADT-28	28
ADT-30	30
ADT-35	35
ADT-38	38
ADT-42	42

ADMMLSE

TAMPÃO MACHO PARA TUBO SEXTAVADO EXTERNO SÉRIE LEVE

COD. ARAFLEX	ROSCA E	TUBO D
ADMMLSE-06	M12X1.5	6
ADMMLSE-08	M14X1.5	8
ADMMLSE-10	M16X1.5	10
ADMMLSE-12	M18X1.5	12
ADMMLSE-15	M22X1.5	15
ADMMLSE-18	M26X1.5	18
ADMMLSE-22	M30X2	22
ADMMLSE-28	M36X2	28
ADMMLSE-35	M45X2	35
ADMMLSE-42	M50X2	42

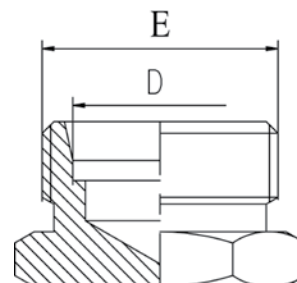

ADMMPSE

TAMPÃO MACHO PARA TUBO SEXTAVADO EXTERNO SÉRIE PESADA

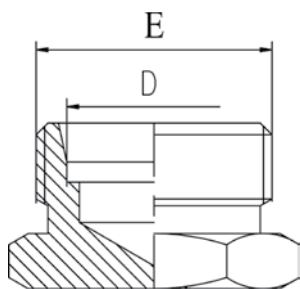

COD. ARAFLEX	ROSCA E	TUBO D
ADMMPSE-06	M14X1.5	6
ADMMPSE-08	M16X1.5	8
ADMMPSE-10	M18X1.5	10
ADMMPSE-12	M20X1.5	12
ADMMPSE-14	M22X1.5	14
ADMMPSE-16	M24X1.5	16
ADMMPSE-20	M30X2	20
ADMMPSE-25	M36X2	25
ADMMPSE-30	M42X2	30
ADMMPSE-38	M52X2	38

____/____/____
DATA

_____ TÍTULO

Form with 20 horizontal dashed lines for text entry.

ADAPTADORES



Conexões **Din**

AA

ANILHA SÉRIE LEVE

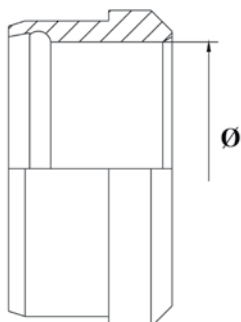

COD. ARAFLEX	TUBO
AA-06	6
AA-08	8
AA-10	10
AA-12	12
AA-15	15
AA-18	18
AA-22	22
AA-28	28
AA-35	35
AA-42	42

AA

ANILHA SÉRIE PESADA

COD. ARAFLEX	TUBO
AA-14	14
AA-16	16
AA-20	20
AA-25	25
AA-30	30
AA-38	38

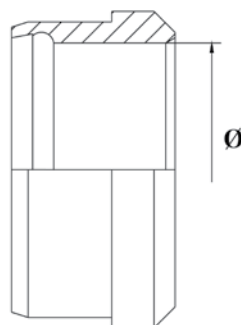

PA

PORCA DIN SÉRIE LEVE

COD. ARAFLEX	ROSCA	TUBO
PA-06-L	M12X1.5	6
PA-08-L	M14X1.5	8
PA-10-L	M16X1.5	10
PA-12-L	M18X1.5	12
PA-15-L	M22X1.5	15
PA-18-L	M26X1.5	18
PA-22-L	M30X2	22
PA-28-L	M36X2	28
PA-35-L	M45X2	35
PA-42-L	M50X2	42

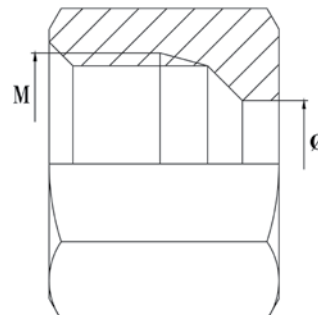

PA

PORCA DIN SÉRIE PESADA

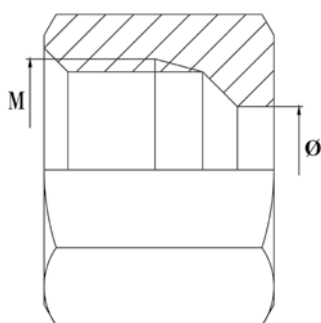

COD. ARAFLEX	ROSCA	TUBO
PA-06-S	M14X1.5	6
PA-08-S	M16X1.5	8
PA-10-S	M18X1.5	10
PA-12-S	M20X1.5	12
PA-14-S	M22X1.5	14
PA-16-S	M24X1.5	16
PA-20-S	M30X2.0	20
PA-25-S	M36X2.0	25
PA-38-S	M52X2.0	38

UMA | BSP

CONEXÃO RETA MACHO MÉTRICO X MACHO ROSCA BSP COM ANEL VEDAÇÃO SÉRIE LEVE

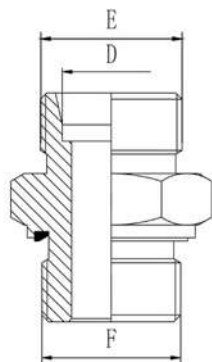

COD. ARAFLEX	TUBO	ROSCA	
	D	E	F
UMA-06X1/8BSP-L	06	1/8-28	1/8-28
UMA-08X1/4BSP-L	08	1/4-19	1/4-19
UMA-08X3/8BSP-L	08	3/8-19	3/8-19
UMA-10X1/4BSP-L	10	1/4-19	1/4-19
UMA-10X1/8BSP-L	10	1/8-28	1/8-28
UMA-10X3/8BSP-L	10	3/8-19	3/8-19
UMA-12X1/2BSP-L	12	1/2-14	1/2-14
UMA-12X1/4BSP-L	12	1/4-19	1/4-19
UMA-12X3/4BSP-L	12	3/4-14	3/4-14
UMA-12X3/8BSP-L	12	3/8-19	3/8-19
UMA-15X1/2BSP-L	15	1/2-14	1/2-14
UMA-15X3/8BSP-L	15	3/8-19	3/8-19
UMA-18X1/2BSP-L	18	1/2-14	1/2-14
UMA-18X1BSP-L	18	1-11	1-11
UMA-18X3/4BSP-L	18	3/4-14	3/4-14
UMA-18X3/8BSP-L	18	3/8-19	3/8-19
UMA-22X3/4BSP-L	22	3/4-14	3/8-19
UMA-28X1.1/4BSP-L	28	1.1/4-11	3/8-19
UMA-28X1BSP-L	28	1-11	3/8-19
UMA-35X1.1/4BSP-L	35	1.1/4-19	3/8-19
UMA-35X1BSP-L	24	1-11	3/8-19
UMA-42X1.1/2BSP-L	42	1.1/2-11	3/8-19

UMA | BSP
**CONEXÃO RETA MACHO MÉTRICO X MACHO
ROSCA BSP COM ANEL VEDAÇÃO SÉRIE PESADA**

COD. ARAFLEX	TUBO	ROSCA	
	D	E	F
UMA-08X1/4BSP-S	08	1/4-19	1/4-19
UMA-08X3/8BSP-S	08	3/8-19	3/8-19
UMA-10X1/4BSP-S	10	1/4-19	1/4-19
UMA-10X3/8BSP-S	10	3/8-19	3/8-19
UMA-12X1/2BSP-S	12	1/2-14	1/2-14
UMA-12X3/8BSP-S	12	3/8-19	3/8-19
UMA-14X1/2BSP-S	14	1/2-14	1/2-14
UMA-16X1/2BSP-S	16	1/2-14	1/2-14
UMA-16X1BSP-S	16	1-11	1-11
UMA-16X3/4BSP-S	16	3/4-14	3/4-14
UMA-16X3/8BSP-S	16	3/8-19	3/8-19
UMA-20X3/4BSP-S	20	3/4-14	3/4-14
UMA-25X1.1/4BSP-S	25	1.1/4-11	1.1/4-11
UMA-25X1BSP-S	25	1-11	1-11
UMA-25X3/4BSP-S	25	3/4-14	3/4-14
UMA-28X3/4BSP-L	28	3/4-14	3/4-14
UMA-30X1.1/2BSP-S	30	1.1/2-11	1.1/2-11
UMA-30X1.1/4BSP-S	30	1.1/4-11	1.1/4-11
UMA-30X1BSP-S	30	1-11	1-11
UMA-38X1.1/2BSP-S	38	1.1/2-11	1.1/2-11
UMA-38X1.1/4BSP-S	38	1.1/4-11	1.1/4-11

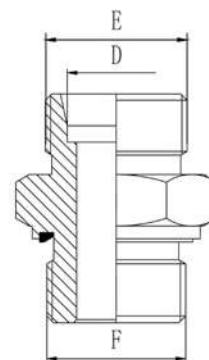

UMA | MM

CONEXÃO RETA MACHO MÉTRICO X MACHO ROSCA MÉTRICA COM ANEL VEDAÇÃO SÉRIE LEVE

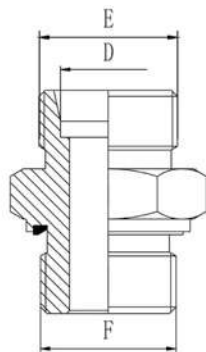

COD. ARAFLEX	TUBO	ROSCA
	D	F
UMA-06XM12-L	06	M12X1.5
UMA-08XM12-L	08	M12X1.5
UMA-10XM12-L	10	M12X1.5
UMA-12XM12-L	12	M12X1.5
UMA-12XM16-L	12	M16X1.5
UMA-12XM18-L	12	M18X1.5
UMA-15XM18-L	15	M18X1.5
UMA-15XM22-L	15	M22X1.5
UMA-18XM22-L	18	M22X1.5
UMA-18XM26-L	18	M26X1.5
UMA-22XM22-L	22	M22X1.5
UMA-22XM26-L	22	M26X2.0
UMA-35XM33-L	35	M33X2.0
UMA-35XM42-L	35	M42X2.0
UMA-42XM48-L	42	M48X2.0

UMA | MM

CONEXÃO RETA MACHO MÉTRICO X MACHO ROSCA MÉTRICA COM ANEL VEDAÇÃO SÉRIE PESADA

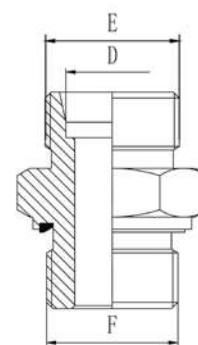

COD. ARAFLEX	TUBO	ROSCA
	D	F
UMA-06XM12-L	06	M12X1.5
UMA-08XM12-L	08	M12X1.5
UMA-10XM12-L	10	M12X1.5
UMA-12XM12-L	12	M12X1.5
UMA-12XM16-L	12	M16X1.5
UMA-12XM18-L	12	M18X1.5
UMA-15XM18-L	15	M18X1.5
UMA-15XM22-L	15	M22X1.5
UMA-18XM22-L	18	M22X1.5
UMA-18XM26-L	18	M26X1.5
UMA-22XM22-L	22	M22X1.5
UMA-22XM26-L	22	M26X2.0
UMA-35XM33-L	35	M33X2.0
UMA-35XM42-L	35	M42X2.0
UMA-42XM48-L	42	M48X2.0

UMA | UNF

CONEXÃO RETA MACHO MÉTRICO X MACHO ROSCA UNF COM ANEL O'RING SÉRIE LEVE

COD. ARAFLEX	TUBO	ROSCA	
	D	E	F
UMA-06X9/16UNF-L	6	M12X1.5	9/16-18
UMA-10X3/4UNF-L	10	M16X1.5	3/4-16
UMA-10X9/16UNF-L	10	M16X1.5	9/16-18
UMA-12X1.1/16UNF-L	12	M18X1.5	1.1/16-16
UMA-12X3/4UNF-L	12	M18X1.5	3/4-16
UMA-12X7/16UNF-L	12	M18X1.5	7/16-20
UMA-12X7/8UNF-L	12	M18X1.5	7/8-14
UMA-12X9/16UNF-L	12	M18X1.5	9/16-18
UMA-15X1.1/16UNF-L	15	M22X1.5	1.1/16-16
UMA-15X1.5/16UNF-L	15	M22X1.5	1.5/16-12
UMA-15X3/4UNF-L	15	M22X1.5	3/4-16
UMA-15X9/16UNF-L	15	M22X1.5	9/16-18
UMA-18X1.1/16UNF-L	18	M26X1.5	1.1/16-16
UMA-18X3/4UNF-L	18	M26X1.5	3/4-16
UMA-18X7/8UNF-L	18	M26X1.5	7/8-14
UMA-22X1.1/16UNF-L	22	M30X2.0	1.1/16-16
UMA-28X1.5/16UNF-L	28	M36X2.0	1.5/16-12
UMA-35X1.5/8UNF-L	35	M45X2.0	1.5/8-12
UMA-42X1.7/8UNF-L	42	M52X2.0	1.7/8-14
UMA-38X1.1/2BSP-S	38	1.1/2-11	1.1/2-11
UMA-38X1.1/4BSP-S	38	1.1/4-11	1.1/4-11

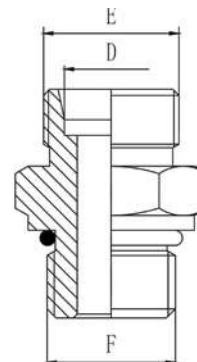

UMA | UNF

CONEXÃO RETA MACHO MÉTRICO X MACHO ROSCA UNF COM ANEL O'RING SÉRIE PESADA

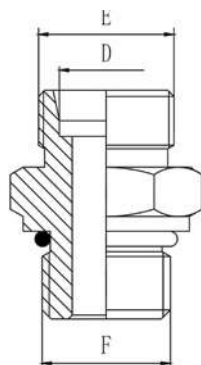

COD. ARAFLEX	TUBO	ROSCA	
	D	E	F
UMA-08X3/4UNF-S	8	M16X1.5	3/4-16
UMA-08X9/16UNF-S	8	M16X1.5	9/16-18
UMA-10X3/4UNF-S	10	M18X1.5	1/2-20
UMA-10X9/16UNF-S	10	M18X1.5	9/16-18
UMA-16X1.1/16UNF-S	16	M24X1.5	1.1/16-16
UMA-16X3/4UNF-S	16	M24X1.5	3/4-16
UMA-16X7/8UNF-S	16	M24X1.5	7/8-14
UMA-20X1.1/16UNF-S	20	M30X2.0	1.1/16-16
UMA-20X7/8UNF-S	20	M30X2.0	7/8-14
UMA-25X1.1/16UNF-S	25	M36X2.0	1.1/16-16
UMA-25X1.5/16UNF-S	25	M36X2.0	1.1/16-16
UMA-30X1.5/8UNF-S	30	M42X2.0	1.5/8-12
UMA-38X1.7/8UNF-S	38	M52X2.0	1.7/8-14
UMA-06X1/4NPT-L	6	M12X1.5	1/4-18

UMA | NPT

CONEXÃO RETA MACHO MÉTRICO X MACHO ROSCA NPT SÉRIE LEVE

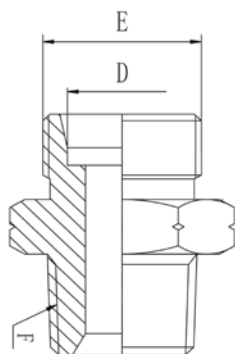

COD. ARAFLEX	TUBO	ROSCA	
	D	E	F
UMA-06X1/4NPT-L	6	M12X1.5	1/4-18
UMA-06X1/8NPT-L	6	M12X1.5	1/8-27
UMA-08X1/4NPT-L	8	M14X1.5	1/4-18
UMA-08X1/8NPT-L	8	M14X1.5	1/8-27
UMA-08X3/8NPT-L	8	M14X1.5	3/8-18
UMA-10X1/4NPT-L	10	M16X1.5	1/4-18
UMA-10X3/8NPT-L	10	M16X1.5	3/8-18
UMA-12X1/2NPT-L	12	M18X1.5	1/2-14
UMA-12X3/8NPT-L	12	M18X1.5	3/8-18
UMA-15X1/2NPT-L	15	M22X1.5	1/2-14
UMA-15X3/4NPT-L	15	M22X1.5	3/4-14
UMA-18X3/4NPT-L	18	M26X1.5	3/4-14
UMA-22X3/4NPT-L	22	M30X2.0	3/4-14
UMA-28X1NPT-L	28	M36X2.0	1-11.5
UMA-35X1.1/4NPT-L	35	M45X2.0	1.1/4-11.5
UMA-42X1.1/2NPT-L	42	M52X2.0	1.1/2-11.5
UMA-42X1.1/4NPT-L	42	M52X2.0	1.1/4-11.5

UMA | NPT

CONEXÃO RETA MACHO MÉTRICO X MACHO ROSCA NPT SÉRIE PESADA

COD. ARAFLEX	TUBO	ROSCA	
	D	E	F
UMA-12X1/2NPT-S	12	M20X1.5	1/2-14
UMA-12X3/8NPT-S	12	M20X1.5	3/8-18
UMA-14X1/2NPT-S	14	M22X1.5	1/2-14
UMA-14X1NPT-S	14	M22X1.5	1-11.5
UMA-14X3/8NPT-S	14	M22X1.5	3/8-18
UMA-16X1/2NPT-S	16	M24X1.5	3/8-18
UMA-16X1NPT-S	16	M24X1.5	1-11.5
UMA-18X3/4NPT-S	18	M24X1.5	3/4-14
UMA-20X3/4NPT-S	20	M30X2.0	3/4-14
UMA-25X1NPT-S	25	M36X2.0	1-11.5
UMA-30X3/4NPT-S	30	M42X2.0	3/4-14

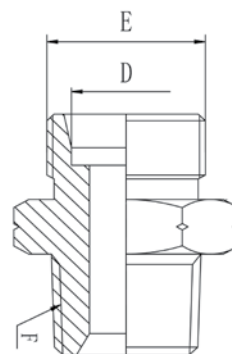

UFA | BSP

CONEXÃO RETA MACHO MÉTRICO X FÊMEA ROSCA BSP SÉRIE LEVE

COD. ARAFLEX	TUBO	ROSCA	
	D	E	F
UFA-06X1/2BSP-L	6	M12X1.5	1/2-14
UFA-10X1/2BSP-L	10	M16X1.5	1/2-14
UFA-10X1/4BSP-L	10	M16X1.5	1/4-19
UFA-10X3/8BSP-L	10	M16X1.5	3/8-19
UFA-12X1/2BSP-L	12	M18X1.5	1/2-14
UFA-12X1/4BSP-L	12	M18X1.5	1/4-19
UFA-12X3/8BSP-L	12	M18X1.5	3/8-19
UFA-15X1/2BSP-L	15	M22X1.5	1/2-14
UFA-22X3/4BSP-L	22	M30X2.0	3/4-14
UFA-28X1BSP-L	28	M36X2.0	1-11

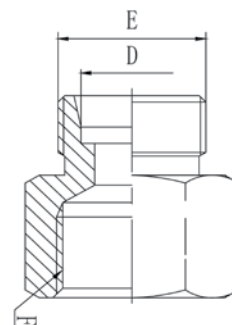

UFA | BSP

CONEXÃO RETA MACHO MÉTRICO X FÊMEA ROSCA BSP SÉRIE PESADA

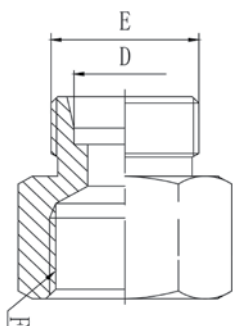

COD. ARAFLEX	TUBO	ROSCA	
	D	E	F
UFA-10X1/4BSP-S	16	M16X1.5	1/4-19
UFA-10X3/8BSP-S	10	M18X1.5	3/8-19
UFA-12X1/2BSP-S	12	M20X1.5	1/2-14
UFA-16X1/2BSP-S	16	M24X1.5	1/2-14
UFA-20X3/4BSP-S	20	M30X2.0	3/4-14
UFA-25X1BSP-S	25	M36X2.0	1-11
UFA-25X3/4BSP-S	25	M36X2.0	3/4-14

UFA

CONEXÃO RETA MACHO MÉTRICO X FÊMEA ROSCA BSP SÉRIE LEVE

COD. ARAFLEX	LINHA	TUBO	ROSCA
		D	E
UFA-12XM16-L	LINHA LEVE	12	M16X1.5
UFA-18XM22-L	LINHA LEVE	18	M22X1.5
UFA-22XM26-L	LINHA LEVE	22	M26X1.5
UFA-35XM42-L	LINHA LEVE	35	M42X2.0
UFA-42XM48-L	LINHA LEVE	42	M48X2.0
UFA-10XM16-S	LINHA PESADA	10	M16X1.5
UFA-12XM18-S	LINHA PESADA	12	M18X1.5
UFA-16XM22-S	LINHA PESADA	16	M22X1.5
UFA-30XM42-S	LINHA PESADA	30	M42X2.0

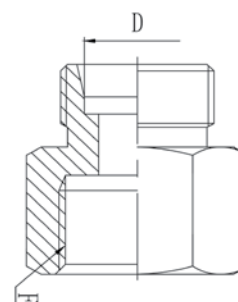

UFA | NPT

CONEXÃO RETA MACHO MÉTRICO X FÊMEA ROSCA NPT SÉRIE LEVE

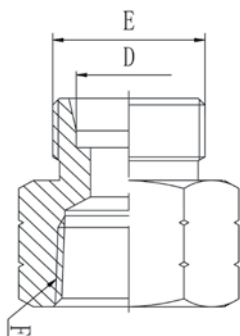

COD. ARAFLEX	TUBO	ROSCA	
	D	E	F
UFA-10X1/4NPT-L	10	M16X1.5	1/4-18
UFA-10X3/8NPT-L	10	M16X1.5	3/8-18
UFA-12X3/8NPT-L	12	M18X1.5	3/8-18
UFA-15X1/2NPT-L	15	M22X1.5	1/2-14
UFA-18X1/2NPT-L	18	M26X1.5	1/2-14
UFA-22X3/4NPT-L	22	M30X2.0	3/4-14
UFA-28X1NPT-L	28	M36X2.0	1-11.5

UFA | NPT

CONEXÃO RETA MACHO MÉTRICO X FÊMEA ROSCA NPT SÉRIE PESADA

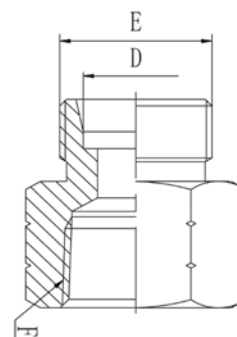

COD. ARAFLEX	TUBO	ROSCA	
	D	E	F
UFA-10X3/8NPT-S	10	M18X1.5	3/8-18
UFA-12X3/8NPT-S	12	M20X1.5	3/8-18
UFA-16X1/2NPT-S	16	M24X1.5	1/2-14
UFA-25X1NPT-S	25	M36X2.0	1-11.5
UFA-25X3/4NPT-S	25	M36X2.0	3/4-14
UFA-30X1.1/4NPT-S	30	M42X2.0	1.1/4-11.5

MAMA | NPT
**CONEXÃO RETA MACHO ROSCA NPT X FÊMEA
DKO SÉRIE LEVE**

COD. ARAFLEX	TUBO	ROSCA	
	D	E	F
MAMA-08X1/4NPT-L	8	M14X1.5	1/4-14
MAMA-08X3/8NPT-L	8	M14X1.5	3/8-18
MAMA-12X3/8NPT-L	12	M18X1.5	3/8-18
MAMA-15X1/2NPT-L	15	M22X1.5	1/2-14
MAMA-18X1/2NPT-L	18	M26X1.5	1/2-14
MAMA-22X1NPT-L	22	M30X2.0	1-11.5
MAMA-22X3/4NPT-L	22	M30X2.0	3/4-14
MAMA-28X1NPT-L	28	M36X2.0	1-11.5

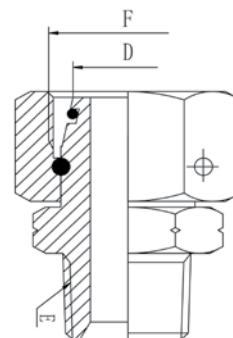
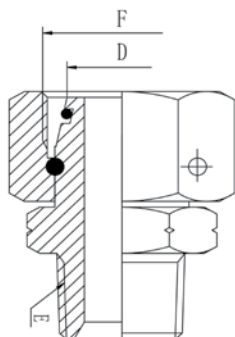
MAMA | NPT
**CONEXÃO RETA MACHO ROSCA NPT X FÊMEA
DKO SÉRIE PESADA**

COD. ARAFLEX	TUBO	ROSCA	
	D	E	F
MAMA-08X1/4NPT-S	8	M16X1.5	1/4-14
MAMA-12X3/8NPT-S	12	M20X1.5	3/8-18
MAMA-14X1/2NPT-S	14	M22X1.5	1/2-14
MAMA-16X1/2NPT-S	16	M24X1.5	1/2-14
MAMA-16X3/4NPT-S	16	M24X1.5	3/4-14
MAMA-20X3/4NPT-S	20	M30X2.0	3/4-14
MAMA-25X1NPT-S	25	M36X2.0	1-11.5
MAMA-25X3/4NPT-S	25	M36X2.0	3/4-14

MAMA | BSP

CONEXÃO RETA MACHO ROSCA BSP COM ANEL DE VEDAÇÃO X FÊMEA DKO SÉRIE LEVE

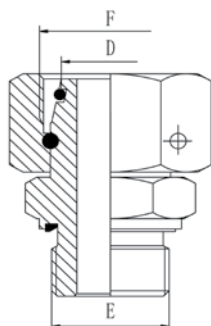

COD. ARAFLEX	TUBO	ROSCA	
	D	E	F
MAMA-08X1/4BSP-L	8	M14X1.5	1/4-19
MAMA-10X1/4BSP-L	10	M16X1.5	1/4-19
MAMA-12X1/2BSP-L	12	M18X1.5	1/2-14
MAMA-12X1/4BSP-L	12	M18X1.5	1/4-19
MAMA-12X3/8BSP-L	12	M18X1.5	3/8-19
MAMA-15X1/2BSP-L	15	M22X1.5	1/2-14
MAMA-18X1/2BSP-L	18	M26X1.5	1/2-14
MAMA-22X3/4BSP-L	22	M30X2.0	3/4-14
MAMA-28X1BSP-L	28	M36X2.0	1-11

MAMA | BSP

CONEXÃO RETA MACHO ROSCA BSP COM ANEL DE VEDAÇÃO X FÊMEA DKO SÉRIE PESADA

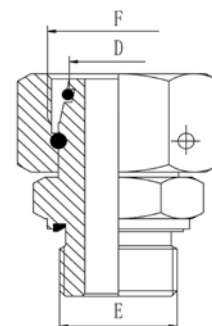

COD. ARAFLEX	TUBO	ROSCA	
	D	E	F
MAMA-06X1/4BSP-S	6	M14X1.5	1/4-19
MAMA-08X1/4BSP-S	8	M16X1.5	1/4-19
MAMA-10X3/8BSP-S	10	M18X1.5	3/8-19
MAMA-12X1/2BSP-S	12	M20X1.5	1/2-14
MAMA-12X3/8BSP-S	12	M20X1.5	3/8-19
MAMA-14X1/2BSP-S	14	M22X1.5	1/2-14
MAMA-16X1/2BSP-S	16	M24X1.5	1/2-14
MAMA-20X3/4BSP-S	20	M30X2.0	3/4-14
MAMA-25X1BSP-S	25	M36X2.0	1-11
MAMA-25X3/4BSP-S	25	M36X2.0	3/4-14

MAMA | MM

CONEXÃO RETA MACHO ROSCA MÉTRICA COM ANEL DE VEDAÇÃO X FÊMEA DKO SÉRIE LEVE

COD. ARAFLEX	TUBO	ROSCA	
	D	E	F
MAMA-06XM10-L	6	M10X1.5	M12X1.5
MAMA-08XM12-L	8	M12X1.5	M14X1.5
MAMA-10XM14-L	10	M14X1.5	M16X1.5
MAMA-12XM16-L	12	M16X1.5	M18X1.5
MAMA-15XM18-L	15	M18X1.5	M22X1.5
MAMA-18XM22-L	18	M22X1.5	M26X1.5

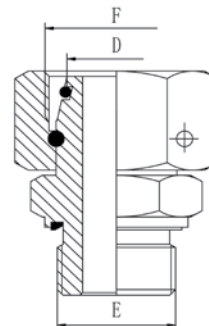

MAMA | MM

CONEXÃO RETA MACHO ROSCA MÉTRICA COM ANEL DE VEDAÇÃO X FÊMEA DKO SÉRIE PESADA

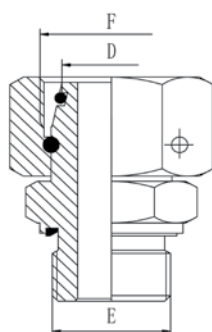

COD. ARAFLEX	TUBO	ROSCA	
	D	E	F
MAMA-06XM12-S	6	M12X1.5	X1.5M14
MAMA-08XM14-S	8	M14X1.5	X1.5M16
MAMA-12XM18-S	12	M18X1.5	X1.5M20
MAMA-14XM20-S	14	M20X1.5	X1.5M22
MAMA-16XM22-S	16	M22X1.5	X1.5M24

JMA

CONEXÃO 90° ROSCA NPT SÉRIE LEVE

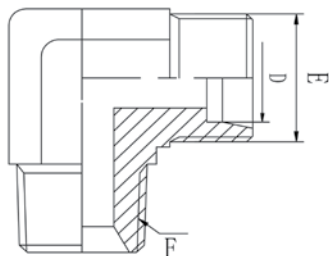

COD. ARAFLEX	TUBO	ROSCA	
	D	E	F
JMA-06X1/4NPT-L	6	M12X1.5	1/4-18
JMA-06X1/8NPT-L	6	M12X1.5	1/8-27
JMA-06X3/8NPT-L	6	M12X1.5	3/8-18
JMA-08X1/4NPT-L	8	M14X1.5	1/4-18
JMA-08X1/8NPT-L	8	M14X1.5	1/8-27
JMA-08X3/8NPT-L	8	M14X1.5	3/8-18
JMA-10X1/4NPT-L	10	M16X1.5	1/4-18
JMA-10X3/8NPT-L	10	M16X1.5	3/8-18
JMA-12X1/2NPT-L	12	M18X1.5	1/2-14
JMA-12X1/4NPT-L	12	M18X1.5	1/4-18
JMA-12X3/8NPT-L	12	M18X1.5	3/8-18
JMA-15X1/2NPT-L	15	M22X1.5	1/2-14
JMA-18X1/2NPT-L	18	M26X1.5	1/2-14
JMA-18X3/4NPT-L	18	M26X1.5	3/4-14
JMA-22X3/4NPT-L	22	M30X2.0	3/4-14
JMA-28X1NPT-L	28	M36X2.0	1-11.5
JMA-35X1.1/2NPT-L	42	M52X2.0	1.1/2-11.5
JMA-35X1.1/4NPT-L	35	M45X2.0	1.1/4-11.5

JMA

CONEXÃO 90° ROSCA NPT SÉRIE PESADA

COD. ARAFLEX	TUBO	ROSCA	
	D	E	F
JMA-08X1/4NPT-S	8	M16X1.5	1/4-18
JMA-10X3/8NPT-S	10	M18X1.5	3/8-18
JMA-12X1/2NPT-S	12	M20X1.5	1/2-14
JMA-12X1/4NPT-S	12	M20X1.5	1/4-18
JMA-12X3/8NPT-S	12	M20X1.5	3/8-18
JMA-14X1/2NPT-S	14	M22X1.5	1/2-14
JMA-14X3/8NPT-S	14	M22X1.5	3/8-18
JMA-16X1/2NPT-S	16	M24X1.5	3/8-18
JMA-20X3/4NPT-S	20	M30X2.0	3/4-14
JMA-25X1NPT-S	25	M36X2.0	1-11.5

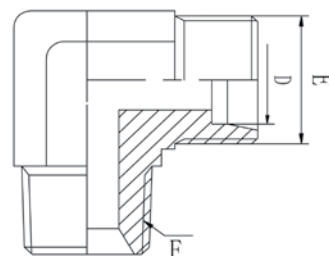

TMA

CONEXÃO TEE MACHO CENTRAL ROSCA NPT SÉRIE LEVE

COD. ARAFLEX	TUBO	ROSCA	
	D	E	F
TMA-08X1/4NPT-L	8	M14X1.5	1/4-18
TMA-10X3/8NPT-L	10	M16X1.5	3/8-18
TMA-12X3/8NPT-L	12	M18X1.5	3/8-18
TMA-15X1/2NPT-L	15	M22X1.5	1/2-14
TMA-18X1/2NPT-L	18	M26X1.5	1/2-14
TMA-22X3/4NPT-L	22	M30X2.0	3/4-14

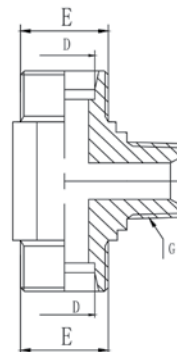

TMA

CONEXÃO TEE MACHO CENTRAL ROSCA NPT SÉRIE PESADA

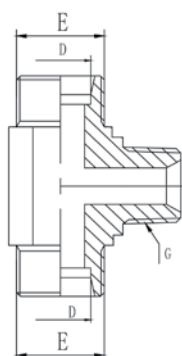

COD. ARAFLEX	TUBO	ROSCA	
	D	E	F
TMA-08X1/4NPT-S	8	M16X1.5	1/4-18
TMA-10X3/8NPT-S	10	M18X1.5	3/8-18
TMA-12X3/8NPT-S	12	M20X1.5	3/8-18
TMA-14X1/2NPT-S	14	M22X1.5	1/2-14
TMA-16X1/2NPT-S	16	M24X1.5	1/2-14
TMA-20X3/4NPT-S	20	M30X2.0	3/4-14
TMA-25X1NPT-S	25	M36X2.0	1-11.5

TVA | NPT

CONEXÃO TEE MACHO LATERAL ROSCA NPT SÉRIE LEVE

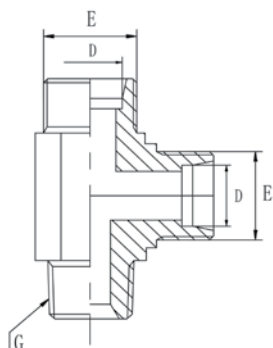

COD. ARAFLEX	TUBO	ROSCA	
	D	E	F
TVA-08X1/4NPT-L	8	M14X1.5	1/4-18
TVA-10X1/4NPT-L	10	M16X1.5	1/4-18
TVA-12X3/8NPT-L	12	M18X1.5	3/8-18
TVA-15X1/2NPT-L	15	M22X1.5	1/2-14
TVA-18X1/2NPT-L	18	M26X1.5	1/2-14
TVA-22X3/4NPT-L	22	M30X2.0	3/4-14
TVA-28X1NPT-L	28	M36X2.0	1-11.5

TVA | NPT

CONEXÃO TEE MACHO LATERAL ROSCA NPT SÉRIE PESADA

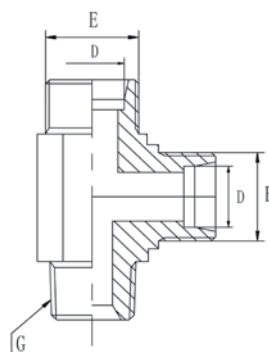

COD. ARAFLEX	TUBO	ROSCA	
	D	E	F
TVA-08X1/4NPT-S	8	M16X1.5	1/4-18
TVA-10X3/8NPT-S	10	M16X1.5	3/8-18
TVA-12X3/8NPT-S	12	M20X1.5	3/8-18
TVA-14X1/2NPT-S	14	M22X1.5	1/2-14
TVA-16X1/2NPT-S	16	M24X1.5	1/2-14
TVA-20X3/4NPT-S	20	M30X2.0	3/4-14
TVA-25X1NPT-S	25	M36X2.0	1-11.5

TVA | BSP
**CONEXÃO TEE LATERAL MACHO ROSCA BSP
ORIENTÁVEL SÉRIE LEVE**

COD. ARAFLEX	TUBO	ROSCA	
	D	E	F
TVA-12X3/8BSP-L	12	M18X1.5	3/8-19
TVA-15X1/2BSP-L	15	M22X1.5	1/2-14
TVA-18X1/2BSP-L	18	M26X1.5	1/2-14
TVA-22X3/4BSP-L	22	M30X1.5	3/4-14
TVA-28X1BSP-L	28	M36X1.5	1-11

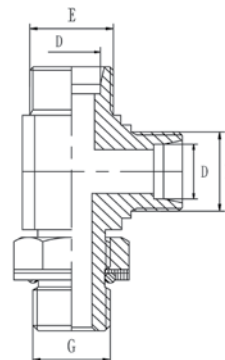
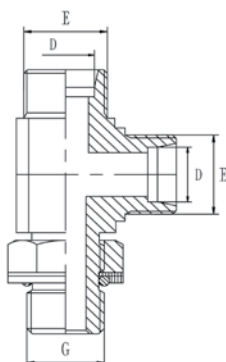
TVA | BSP
**CONEXÃO TEE LATERAL MACHO ROSCA BSP
ORIENTÁVEL SÉRIE PESADA**

COD. ARAFLEX	TUBO	ROSCA	
	D	E	F
TVA-10X3/8BSP-S	10	M18X1.5	3/8-19
TVA-14X1/2BSP-S	14	M22X1.5	1/2-14
TVA-16X1/2BSP-S	16	M24X1.5	1/2-14
TVA-20X3/4BSP-S	20	M30X2.0	3/4-14
TVA-20X3/4NPT-S	20	M30X2.0	3/4-14
TVA-25X1BSP-S	25	M36X2.0	1-11

UDA

CONEXÃO IGUAL RETA SÉRIE LEVE

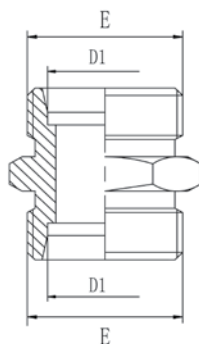

COD. ARAFLEX	TUBO	ROSCA
	D	E
UDA-06-L	6	M12X1.5
UDA-08-L	8	M14X1.5
UDA-10-L	10	M16X1.5
UDA-12-L	12	M18X1.5
UDA-15-L	15	M22X1.5
UDA-18-L	18	M26X1.5
UDA-22-L	22	M30X2.0
UDA-28-L	28	M36X2.0
UDA-35-L	35	M45X2.0
UDA-42-L	42	M52X2.0

UDA

CONEXÃO IGUAL RETA SÉRIE PESADA

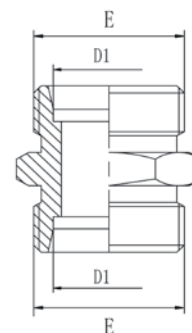

COD. ARAFLEX	TUBO	ROSCA
	D	E
UDA-06-S	6	M14X1.5
UDA-08-S	8	M16X1.5
UDA-10-S	10	M18X1.5
UDA-12-S	12	M20X1.5
UDA-14-S	14	M22X1.5
UDA-16-S	16	M24X1.5
UDA-20-S	20	M30X2.0
UDA-25-S	25	M36X2.0
UDA-30-S	30	M42X2.0
UDA-38-S	38	M52X2.0

UCA

CONEXÃO IGUAL RETA PAINEL

COD. ARAFLEX	LINHA	TUBO	ROSCA
		D	E
UCA-12-L	LINHA LEVE	12	M18X1.5
UCA-15-L	LINHA LEVE	15	M22X1.5
UCA-18-L	LINHA LEVE	18	M26X1.5
UCA-22-L	LINHA LEVE	22	M30X2.0
UCA-28-L	LINHA LEVE	28	M36X2.0
UCA-06-S	LINHA PESADA	6	M14X1.5
UCA-16-S	LINHA PESADA	16	M24X1.5
UCA-20-S	LINHA PESADA	20	M30X2.0
UCA-25-S	LINHA PESADA	25	M36X2.0
UCA-30-S	LINHA PESADA	30	M42X2.0
UCA-38-S	LINHA PESADA	38	M52X2.0

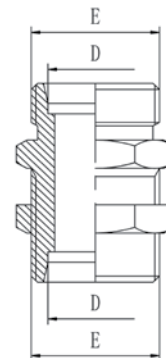

JCA

CONEXÃO IGUAL 90° PAINEL

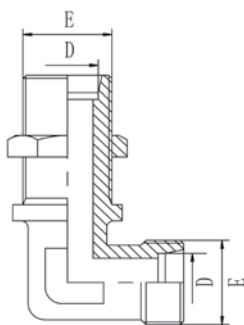

COD. ARAFLEX	LINHA	TUBO	ROSCA
		D	E
UDA-12-L	LINHA LEVE	12	M18X1.5
UDA-15-L	LINHA LEVE	15	M22X1.5
UDA-18-L	LINHA LEVE	18	M26X1.5
UDA-22-L	LINHA LEVE	22	M30X2.0
UDA-28-L	LINHA LEVE	28	M36X2.0
UDA-06-S	LINHA PESADA	6	M14X1.5
UDA-12-S	LINHA PESADA	12	M20X1.5
UDA-16-S	LINHA PESADA	16	M24X1.5
UDA-20-S	LINHA PESADA	20	M30X2.0
UDA-25-S	LINHA PESADA	25	M36X2.0
UDA-30-S	LINHA PESADA	30	M42X2.0
UDA-38-S	LINHA PESADA	38	M52X2.0

JIA

CONEXÃO IGUAL 90°

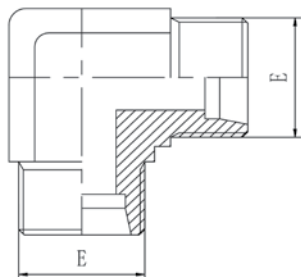

COD. ARAFLEX	LINHA	TUBO	ROSCA
		D	E
JIA-06-L	LINHA LEVE	6	M12X1.5
JIA-08-L	LINHA LEVE	8	M14X1.5
JIA-10-L	LINHA LEVE	10	M16X1.5
JIA-12-L	LINHA LEVE	12	M18X1.5
JIA-15-L	LINHA LEVE	15	M22X1.5
JIA-18-L	LINHA LEVE	18	M26X1.5
JIA-22-L	LINHA LEVE	22	M30X2.0
JIA-28-L	LINHA LEVE	28	M36X2.0
JIA-35-L	LINHA LEVE	35	M45X2.0
JIA-42-L	LINHA LEVE	42	M52X2.0
JIA-06-S	LINHA PESADA	6	M14X1.5
JIA-08-S	LINHA PESADA	8	M16X1.5
JIA-10-S	LINHA PESADA	10	M18X1.5
JIA-12-S	LINHA PESADA	12	M20X1.5
JIA-14-S	LINHA PESADA	14	M22X1.5
JIA-16-S	LINHA PESADA	16	M24X1.5
JIA-20-S	LINHA PESADA	20	M30X2.0
JIA-25-S	LINHA PESADA	25	M36X2.0
JIA-30-S	LINHA PESADA	30	M42X2.0
JIA-38-S	LINHA PESADA	38	M52X2.0

TIA

CONEXÃO TEE IGUAL

COD. ARAFLEX	LINHA	TUBO	ROSCA
		D	E
TIA-06-L	LINHA LEVE	6	M12X1.5
TIA-08-L	LINHA LEVE	8	M14X1.5
TIA-10-L	LINHA LEVE	10	M16X1.5
TIA-12-L	LINHA LEVE	12	M18X1.5
TIA-15-L	LINHA LEVE	15	M22X1.5
TIA-18-L	LINHA LEVE	18	M26X1.5
TIA-22-L	LINHA LEVE	22	M30X2.0
TIA-28-L	LINHA LEVE	28	M36X2.0
TIA-08-S	LINHA PESADA	8	M16X1.5
TIA-10-S	LINHA PESADA	10	M18X1.5
TIA-12-S	LINHA PESADA	12	M20X1.5
TIA-14-S	LINHA PESADA	14	M22X1.5
TIA-16-S	LINHA PESADA	16	M24X1.5
TIA-20-S	LINHA PESADA	20	M30X2.0
TIA-25-S	LINHA PESADA	25	M36X2.0
TIA-30-S	LINHA PESADA	30	M42X2.0

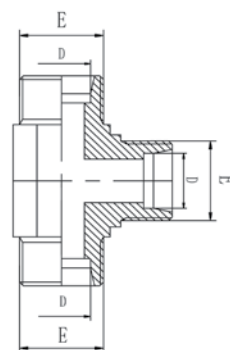

UDRA

CONEXÃO REDUÇÃO RETA

COD. ARAFLEX	LINHA	TUBO	ROSCA
		D1	D2
UDRA-12X10-L	LINHA LEVE	12	10
UDRA-15X12-L	LINHA LEVE	15	12
UDRA-18X10-L	LINHA LEVE	18	10
UDRA-18X12-L	LINHA LEVE	18	12
UDRA-18X15-L	LINHA LEVE	18	15
UDRA-22X12-L	LINHA LEVE	22	12
UDRA-22X15-L	LINHA LEVE	22	15
UDRA-22X18-L	LINHA LEVE	22	18
UDRA-12X08-S	LINHA PESADA	12	8
UDRA-14X10-S	LINHA PESADA	14	10
UDRA-20X10-S	LINHA PESADA	20	10
UDRA-20X12-S	LINHA PESADA	20	12
UDRA-25X16-S	LINHA PESADA	25	16

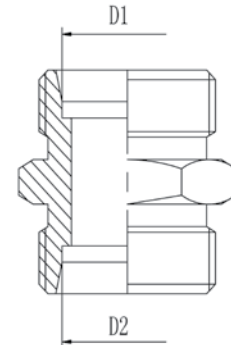

MJLA

CONEXÃO 90° FÊMEA DKO

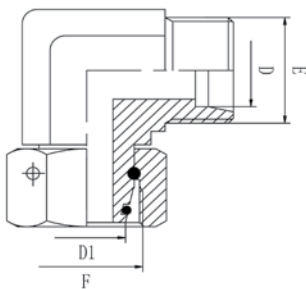

COD. ARAFLEX	LINHA	TUBO	ROSCA
		D	
MJLA-06-L	LINHA LEVE	M12X1.5	6
MJLA-08-L	LINHA LEVE	M14X1.5	8
MJLA-10-L	LINHA LEVE	M16X1.5	10
MJLA-12-L	LINHA LEVE	M18X1.5	12
MJLA-15-L	LINHA LEVE	M22X1.5	15
MJLA-18-L	LINHA LEVE	M26X1.5	18
MJLA-22-L	LINHA LEVE	M30X2.0	22
MJLA-28-L	LINHA LEVE	M36X2.0	28
MJLA-35-L	LINHA LEVE	M45X2.0	35
MJLA-10-S	LINHA PESADA	M18X1.5	10
MJLA-12-S	LINHA PESADA	M20X1.5	12
MJLA-14-S	LINHA PESADA	M22X1.5	14
MJLA-16-S	LINHA PESADA	M24X1.5	16
MJLA-20-S	LINHA PESADA	M30X2.0	20
MJLA-25-S	LINHA PESADA	M36X2.0	25
MJLA-30-S	LINHA PESADA	M42X2.0	30
MJLA-38-S	LINHA PESADA	M52X2.0	38

MTVLA

CONEXÃO TEE LATERAL FÊMEA DKO

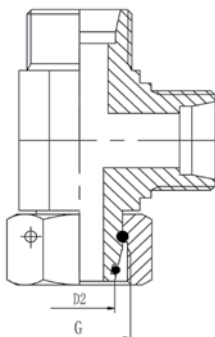

COD. ARAFLEX	LINHA	TUBO D	ROSCA
MTVLA-10-L	LINHA LEVE	M16X1.5	10
MTVLA-12-L	LINHA LEVE	M18X1.5	12
MTVLA-15-L	LINHA LEVE	M22X1.5	15
MTVLA-18-L	LINHA LEVE	M26X1.5	18
MTVLA-22-L	LINHA LEVE	M30X2.0	22
MTVLA-28-L	LINHA LEVE	M36X2.0	28
MTVLA-10-S	LINHA PESADA	M18X1.5	10
MTVLA-12-S	LINHA PESADA	M20X1.5	12
MTVLA-14-S	LINHA PESADA	M22X1.5	14
MTVLA-16-S	LINHA PESADA	M24X1.5	16
MTVLA-20-S	LINHA PESADA	M30X2.0	20
MTVLA-25-S	LINHA PESADA	M36X2.0	25
MTVLA-30-S	LINHA PESADA	M42X2.0	30

MTLA

CONEXÃO TEE CENTRAL FÊMEA DKO

COD. ARAFLEX	LINHA	TUBO D	ROSCA
MTLA-10-L	LINHA LEVE	M16X1.5	10
MTLA-12-L	LINHA LEVE	M18X1.5	12
MTLA-15-L	LINHA LEVE	M22X1.5	15
MTLA-18-L	LINHA LEVE	M26X1.5	18
MTLA-22-L	LINHA LEVE	M30X2.0	22
MTLA-28-L	LINHA LEVE	M36X2.0	28
MTLA-10-S	LINHA PESADA	M18X1.5	10
MTLA-12-S	LINHA PESADA	M20X1.5	12
MTLA-14-S	LINHA PESADA	M22X1.5	14
MTLA-16-S	LINHA PESADA	M24X1.5	16
MTLA-20-S	LINHA PESADA	M30X2.0	20
MTLA-25-S	LINHA PESADA	M36X2.0	25
MTLA-30-S	LINHA PESADA	M42X2.0	30

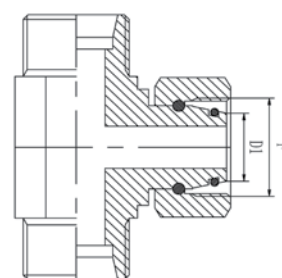

MATA

CONEXÃO REDUÇÃO RETA MACHO X FÊMEA SÉRIE LEVE

COD. ARAFLEX	TUBO		ROSCA
	D1	D2	
MATA-08X06-L	M14X1.5	8	6
MATA-15X12-L	M22X1.5	15	12
MATA-18X12-L	M26X1.5	18	12
MATA-28X12-L	M36X2.0	28	12
MATA-28X22-L	M36X2.0	28	22

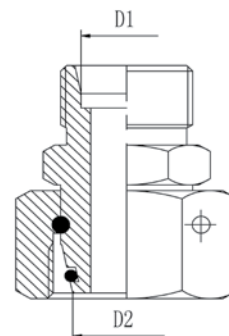

MATA

CONEXÃO REDUÇÃO RETA MACHO X FÊMEA SÉRIE PESADA

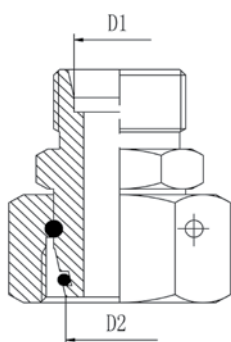

COD. ARAFLEX	TUBO		ROSCA
	D1	D2	
MATA-20X12-S	M30X2.0	20	12
MATA-20X16-S	M30X2.0	20	16
MATA-30X25-S	M42X2.0	30	25

MALA

CONEXÃO EMENDA DKO

COD. ARAFLEX	LINHA	TUBO	ROSCA
		D	
MALA-10-L	LINHA LEVE	M16X1.5	10
MALA-12-L	LINHA LEVE	M18X1.5	12
MALA-15-L	LINHA LEVE	M22X1.5	15
MALA-18-L	LINHA LEVE	M26X1.5	18
MALA-22-L	LINHA LEVE	M30X2.0	22
MALA-28-L	LINHA LEVE	M36X2.0	28
MALA-10-S	LINHA PESADA	M18X1.5	10
MALA-12-S	LINHA PESADA	M20X1.5	12
MALA-14-S	LINHA PESADA	M22X1.5	14
MALA-16-S	LINHA PESADA	M24X1.5	16
MALA-20-S	LINHA PESADA	M30X2.0	20
MALA-25-S	LINHA PESADA	M36X2.0	25
MALA-30-S	LINHA PESADA	M42X2.0	30

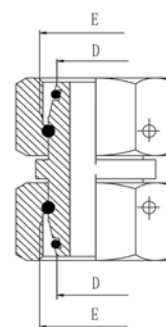

JOA | BSP

CONEXÃO 90° MACHO ORIENTÁVEL ROSCA BSP SÉRIE LEVE

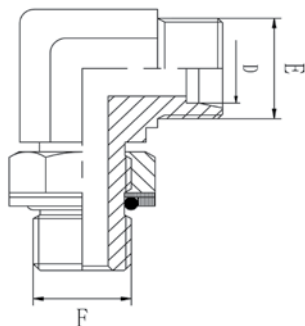

COD. ARAFLEX	TUBO	ROSCA	
	D	E	F
JOA-06X1/4BSP-L	6	M12X1.5	1/4-19
JOA-06X1/8BSP-L	6	M12X1.5	1/8-28
JOA-08X1/4BSP-L	8	M14X1.5	1/4-19
JOA-10X1/4BSP-L	10	M16X1.5	1/4-19
JOA-10X3/8BSP-L	10	M16X1.5	3/8-19
JOA-12X1/2BSP-L	18	M12X1.5	1/2-14
JOA-12X3/8BSP-L	18	M12X1.5	3/8-19
JOA-15X1/2BSP-L	15	M22X1.5	1/2-14
JOA-18X1/2BSP-L	18	M26X1.5	1/2-14
JOA-22X3/4BSP-L	22	M30X2.0	3/4-14
JOA-28X1BSP-L	28	M36X2.0	1-11
JOA-30X1.1/4BSP-L	30	M42X2.0	1.1/4-11
JOA-35X1.1/4BSP-L	35	M45X2.0	1.1/4-11

JOA | BSP

CONEXÃO 90° MACHO ORIENTÁVEL ROSCA BSP SÉRIE PESADA

COD. ARAFLEX	TUBO	ROSCA	
	D	E	F
JOA-08X1/4BSP-S	8	M16X1.5	1/4-19
JOA-10X3/8BSP-S	10	M18X1.5	3/8-19
JOA-12X1/2BSP-S	12	M20X1.5	1/2-14
JOA-12X3/8BSP-S	12	M20X1.5	3/8-19
JOA-14X1/2BSP-S	14	M22X1.5	1/2-14
JOA-16X1/2BSP-S	16	M26X1.5	1/2-14
JOA-16X1BSP-S	16	M26X1.5	1/2-14
JOA-16X3/4BSP-S	16	M26X1.5	3/4-14
JOA-16X3/8BSP-S	16	M26X1.5	3/8-19
JOA-20X3/4BSP-S	20	M30X2.0	3/4-14
JOA-25X1BSP-S	25	M36X2.0	1-11

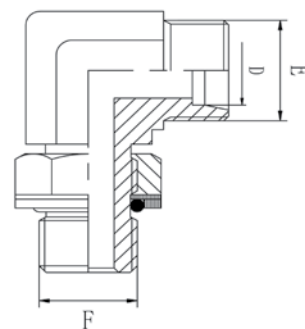

JOA | UNF

CONEXÃO 90° MACHO ORIENTÁVEL ROSCA UNF SÉRIE LEVE

COD. ARAFLEX	TUBO	ROSCA	
	D	E	F
JOA-06X7/16UNF-L	6	M12X1.5	7/16-20
JOA-08X7/16UNF-L	8	M14X1.5	7/16-20
JOA-10X9/16UNF-L	10	M16X1.5	9/16-18
JOA-12X3/4UNF-L	12	M18X1.5	3/4-16
JOA-22X1.1/16UNF-L	22	M30X2.0	1.1/16-12
JOA-28X1.5/16UNF-L	28	M36X2.0	1.5/16-12

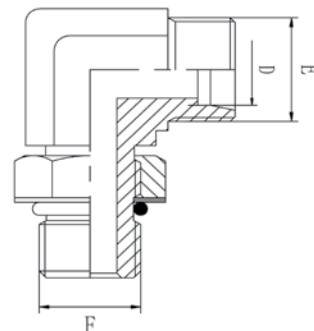

JOA | UNF

CONEXÃO 90° MACHO ORIENTÁVEL ROSCA UNF SÉRIE PESADA

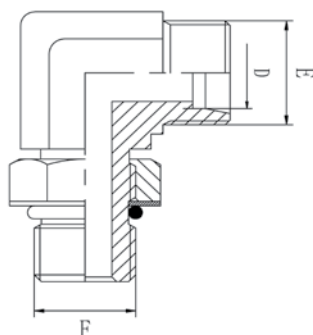

COD. ARAFLEX	TUBO	ROSCA	
	D	E	F
JOA-10X9/16UNF-S	10	M18X1.5	9/16-18
JOA-12X3/4UNF-S	12	M20X1.5	3/4-16
JOA-12X9/16UNF-S	12	M20X1.5	9/16-18
JOA-14X3/4UNF-S	14	M22X1.5	3/4-16
JOA-16X1.1/16UNF-S	16	M24X1.5	1.1/16-12
JOA-16X3/4UNF-S	16	M24X1.5	3/4-16
JOA-20X1.1/16UNF-S	20	M30X2.0	1.1/16-12
JOA-20X1.5/16UNF-S	20	M30X2.0	1.5/16-12
JOA-25X1.1/16UNF-S	25	M36X2.0	1.1/16-12
JOA-25X1.5/16UNF-S	25	M36X2.0	1.5/16-12



Acessórios

FLSPLIT3

SPLIT FLANGE COD. 61

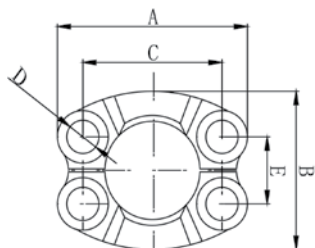

COD. ARAFLEX	FLANGE	PARAFUSO	DIMENSÃO				
			A	B	C	D	E
FLSPLIT3-08	1/2"	M8X25	53.8	46.1	17.5	9	17.5
FLSPLIT3-12	3/4"	M10X30	65	52.4	22.2	11	22.2
FLSPLIT3-16	1"	M10X30	69.9	58.7	26.2	11	26.2
FLSPLIT3-20	1.1/4"	M10X30	79.2	73	30.2	11	30.2
FLSPLIT3-24	1.1/2"	M12X35	93.7	82.6	35.7	13.5	35.7
FLSPLIT3-32	2"	M12X35	101.6	96.8	42.9	13.5	42.9

FLSPLIT6

SPLIT FLANGE COD. 62

COD. ARAFLEX	FLANGE	PARAFUSO	DIMENSÃO				
			A	B	C	D	E
FLSPLIT6-08	1/2"	M8X30	56.3	49.2	40.5	9	18.2
FLSPLIT6-12	3/4"	M10X35	71.4	61.8	50.8	11	23.8
FLSPLIT6-16	1"	M12X45	81	71.4	57.2	13	27.8
FLSPLIT6-20	1.1/4"	M14X30	95.3	79.2	66.7	15	31.8
FLSPLIT6-24	1.1/2"	M16X55	112.8	96.8	79.4	17	36.6
FLSPLIT6-32	2"	M20X70	133.4	115.6	96.8	21	44.4

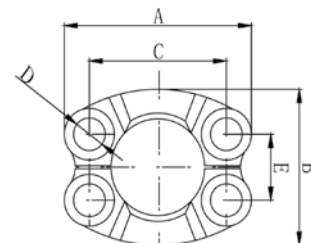

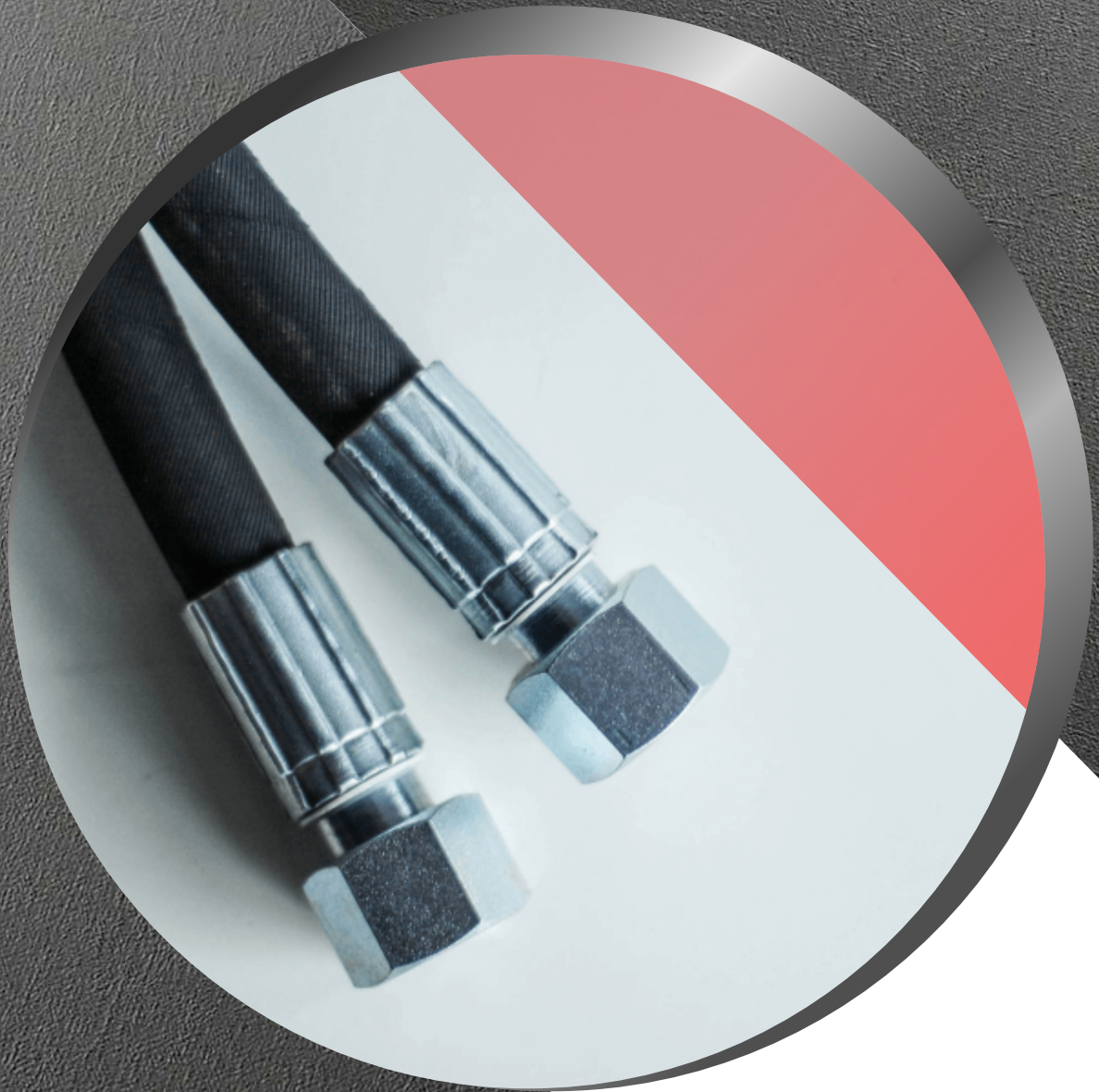

Mangueiras

100R1

SAE 100 R1AT/1SN
ISO1436-1 - EN 853



Características Gerais

Construção: Tubo interno de borracha sintética com uma camada de fio de aço trançado, coberta com borracha sintética resistente a intempérie

Temperatura de Trabalho: -40 °C | +100 °C

Aplicação: Equipamentos Hidráulicos, com picos de pressões e condições extremas de operações, fluidos comuns minerais e sintéticos

Tamanho		Diâmetro Interno			Diâmetro Externo		Pressão de Trabalho		Pressão de Ruptura		Raio de Curvatura
Polegada	Traço	Nom (mm)	Min (mm)	Max (mm)	Min (mm)	Max (mm)	(Bar)	(Psi)	(Bar)	(Psi)	(mm)
3/16"	03	4.8	4.6	5.4		12.5	207	3000	827	12000	89
1/4"	04	6.4	6.2	7.0		14.1	189	2750	758	11000	102
5/16"	05	7.9	7.7	8.5		15.7	172	2500	689	10000	114
3/8"	06	9.5	9.3	10.1		18.1	155	2250	620	9000	127
1/2"	08	12.7	12.3	13.5		21.5	138	2000	551	8000	178
5/8"	10	15.9	15.5	16.7		24.7	103	1500	413	6000	203
3/4"	12	19.0	18.6	19.8		28.6	86	1250	345	5000	241
1"	16	25.4	25.0	26.4		36.6	69	1000	276	4000	305
1 1/4"	20	31.8	31.4	33.0		44.8	43	625	172	2500	419
1 1/2"	24	38.1	37.7	39.3		52.0	34	500	138	2000	508
2"	32	50.8	50.4	52.0		65.9	26	375	103	1500	635

Características Gerais

Construção: Tubo interno de borracha sintética com duas camadas de fio de aço trançado, coberta com borracha sintética resistente a intempérie

Temperatura de Trabalho: -40 °C | +100 °C

Aplicação: Equipamentos Hidráulicos, com picos de pressões e condições extremas de operações, fluidos comuns minerais e sintéticos

100R2

SAE 100 R2AT/2SN
ISO1436-1 - EN 853



Tamanho		Diâmetro Interno			Diâmetro Externo		Pressão de Trabalho		Pressão de Ruptura		Raio de Curvatura
Polegada	Traço	Nom (mm)	Min (mm)	Max (mm)	Min (mm)	Max (mm)	(Bar)	(Psi)	(Bar)	(Psi)	(mm)
3/16"	03	4.8	4.6	5.4		14.1	345	5000	1378	20000	89
1/4"	04	6.4	6.2	7.0		15.7	345	5000	1378	20000	102
5/16"	05	7.9	7.7	8.5		17.3	293	4250	1171	17000	114
3/8"	06	9.5	9.3	10.1		19.7	276	4000	1102	16000	127
1/2"	08	12.7	12.3	13.5		23.1	241	3500	965	14000	178
5/8"	10	15.9	15.5	16.7		26.3	189	2750	758	11000	203
3/4"	12	19.0	19.6	19.8		30.2	155	2250	620	9000	241
1"	16	25.4	25.0	26.4		38.9	138	2000	551	8000	305
1 1/4"	20	31.8	31.4	33.0		49.6	112	1625	448	6500	419
1 1/2"	24	38.1	37.7	39.3		56.0	86	1250	345	5000	508
2"	32	50.8	50.4	52.0		68.6	78	1125	310	4500	635

100R3

SAE 100R3

Características Gerais

Construção: Tubo interno de borracha sintética com duas camadas de fio de fibra trançado, coberta com borracha sintética resistente a intempérie

Temperatura de Trabalho: -40 °C | +100 °C

Aplicação: Equipamentos Hidráulicos, com pressões intermediária. Fluidos comuns a base de petróleo.



Tamanho		Diâmetro Interno		Diâmetro Externo		Pressão de Trabalho		Pressão de Ruptura		Raio de Curvatura
Polegada	Traço	Min	Max	Min	Max	Mpa	Psi	Mpa	Psi	mm
3/16"	03	4.5	5.4	11.9	13.5	10.5	1520	42	6090	75
1/4"	04	6.1	7.0	13.5	15.1	8.7	1260	35	5075	75
5/16"	05	7.6	8.5	16.7	18.3	8.4	1220	33.5	4860	100
3/8"	06	9.2	10.1	18.3	19.8	7.8	1130	31.5	4570	100
1/2"	08	12.4	13.5	23.0	24.6	7.0	1015	28	4060	125
5/8"	10	15.6	16.7	26.2	27.8	6.1	885	24.5	3550	140
3/4"	12	18.7	19.8	31.0	32.5	5.2	750	21	3045	150
1"	16	25.1	26.2	36.9	39.3	3.9	570	15.7	2280	205
1 1/4"	20	31.4	32.9	42.9	46.0	2.6	380	10.5	1520	250

100R5

SAE 100R5

Características Gerais

Construção: Tubo interno de borracha sintética com uma camada de fio de fibra sintética, reforçada com outra camada de fio.

Temperatura de Trabalho: -40 °C | +100 °C

Aplicação: Equipamentos Hidráulicos, com pressões intermediária. Fluidos comuns a base de petróleo.

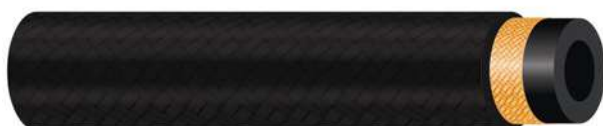

Tamanho		Diâmetro Interno		Diâmetro Externo		Pressão de Trabalho		Pressão de Ruptura		Raio de Curvatura
Polegada	Traço	Min	Max	Min	Max	Mpa	Psi	Mpa	Psi	mm
3/16"	-04	4.8	5.5	12.7	13.7	21	3045	84	12180	75
1/4"	-05	6.4	7.2	14.3	15.3	21	3045	84	12180	85
5/16"	-06	7.9	8.7	16.7	17.6	15.7	2270	63	9135	100
13/32"	-08	10.3	11.1	18.9	20.0	14	2030	56	8120	115
1/2"	-10	12.7	13.7	22.8	24.0	12.2	1770	49	7105	140
5/8"	-12	12.9	17.0	26.8	28.0	10.5	1520	42	6090	165
7/8"	-16	22.2	23.3	30.6	32.2	5.6	810	22.4	3250	185
1 1/8"	-20	28.6	29.8	37.3	38.9	4.3	620	17.5	2540	230
1 3/8"	-24	34.9	36.1	43.7	45.2	3.5	510	14	2030	265
1 13/16"	-32	46.0	47.2	55.2	57.6	2.4	350	9.8	1420	335
2 3/8"	-40	60.3	61.9	71.8	74.2	2.4	350	9.8	1420	610
3"	-48	76.24	77.8	89.3	91.7	1.4	200	5.6	810	840

100R6

SAE 100R6



Características Gerais

Construção: Tubo interno de borracha sintética com uma camada de fio de fibra adequada, cobertura de borracha sintética resistente a intempérie.

Temperatura de Trabalho: -40 °C | +100 °C

Aplicação: Equipamentos Hidráulicos, com pressões intermediária. Fluidos comuns a base de petróleo.

Tamanho		Diâmetro interno		Diâmetro Externo		Pressão de Trabalho		Pressão de Ruptura		Raio de Curvatura
Polegada	Traço	Min	Max	Min	Max	Mpa	Psi	Mpa	Psi	mm
3/16"	-03	4.5	5.4	10.3	11.9	3.5	510	14	2030	50
1/4"	-04	6.1	7.0	11.9	13.5	2.8	410	11.2	1620	65
5/16"	-05	7.6	8.5	13.5	15.1	2.8	410	11.2	1620	75
3/8"	-06	9.2	10.1	15.1	16.7	2.8	410	11.2	1620	75
1/2"	-08	12.4	13.5	19.0	20.6	2.8	410	11.2	1620	100
5/8"	-10	15.6	16.7	22.2	23.8	2.4	350	9.8	1420	125
3/4"	-12	18.7	19.8	25.4	27.8	2.1	310	8.4	1220	150

Características Gerais

Construção: Tubo interno termoplástico resistente a óleo hidráulico com reforço adequado de fibra sintética e cobertura de material termoplástico.

Temperatura de Trabalho: -40 °C | +100 °C

Aplicação: Equipamentos Hidráulicos, fluidos comuns a base de petróleo.

100R7 / 100R8

SAE 100R7 / SAE 100R8



Tamanho		Diâmetro Interno		Diâmetro Externo	Pressão de Trabalho		Pressão de Ruptura		Raio de Curvatura
Polegada	Traço	Min	Max	Max	Mpa	Psi	Mpa	Psi	mm
3/16"	-03	4.6	5.4	11.4	21	3045	84	12180	90
1/4"	-04	6.2	7.0	13.7	19.2	2780	77	11165	100
5/16"	-05	7.7	8.5	15.6	17.5	2535	70	10150	115
3/8"	-06	9.3	10.3	18.4	15.7	2275	63	9135	125
1/2"	-08	12.3	13.5	22.5	14	2030	56	8120	180
5/8"	-10	15.5	16.7	25.8	10.5	1520	42	6090	205
3/4"	-12	18.6	19.8	28.6	8.7	1260	35	5075	240
1"	-16	25.0	26.4	36.7	7	1015	28	4060	300

100R7 Laranja

SAE 100R7 Laranja

Características Gerais

Construção: Tubo interno termoplástico resistente a óleo hidráulico com reforço adequado de fibra sintética NÃO CONDUTIVA e cobertura de material termoplástico.

Temperatura de Trabalho: -40 °C | +100 °C

Aplicação: Equipamentos Hidráulicos, fluidos comuns a base de petróleo.



Tamanho		Diâmetro Interno		Diâmetro Externo		Pressão de Trabalho		Pressão de Ruptura		Raio de Curvatura
Polegada	Traço	Min	Max	Max	Mpa	Psi	Mpa	Psi	mm	
3/16"	-03	4.6	5.4	11.4	21	3045	84	12180	90	
1/4"	-04	6.2	7.0	13.7	19.2	2780	77	11165	100	
5/16"	-05	7.7	8.5	15.6	17.5	2535	70	10150	115	
3/8"	-06	9.3	10.3	18.4	15.7	2275	63	9135	125	
1/2"	-08	12.3	13.5	22.5	14	2030	56	8120	180	
5/8"	-10	15.5	16.7	25.8	10.5	1520	42	6090	205	
3/4"	-12	18.6	19.8	28.6	8.7	1260	35	5075	240	
1"	-16	25.0	26.4	36.7	7	1015	28	4060	300	

100R12

SAE 100R12

Características Gerais

Construção: Tubo interno de borracha sintética com quatro camadas de fio de aço trançado em direções alternadas, coberta com borracha sintética resistente a intempérie

Temperatura de Trabalho: -40 °C | +100 °C

Aplicação: Equipamentos Hidráulicos, com picos de pressões alta e condições extremas de operações, fluidos comuns minerais e sintéticos.



Tamanho		Diâmetro Interno		Diâmetro Externo		Pressão de Trabalho		Pressão de Ruptura		Raio de Curvatura
Polegada	Traço	Min	Max	Min	Max	Mpa	Psi	Mpa	Psi	mm
3/8"	-06	9.3	10.1	19.5	21.0	28	4060	112	16240	125
1/2"	-08	12.3	13.5	23.0	24.6	28	4060	112	16240	180
5/8"	-10	15.5	16.7	26.6	28.2	28	4060	112	16240	200
3/4"	-12	18.6	19.8	29.9	31.7	28	4060	112	16240	240
1"	-16	25.0	26.4	36.8	39.4	28	4060	112	16240	300
1 1/4"	-20	31.4	33.0	45.4	48.6	21	3045	84	12180	420
1 1/2"	-24	37.7	39.3	51.9	55.0	17.5	2540	70	10150	500
2"	-32	50.8	52.0	65.1	68.3	17.5	2540	70	10150	640

100R13

SAE 100R13



Características Gerais

Construção: Tubo interno de borracha sintética com quatro camadas múltiplas de fio de aço trançado em espirais e direções alternadas, coberta com borracha sintética resistente a intempérie

Temperatura de Trabalho: -40 °C | +100 °C

Aplicação: Equipamentos Hidráulicos, com picos de pressões alta e condições extremas de operações, fluidos comuns minerais e sintéticos.

Tamanho		Diâmetro Interno		Diâmetro Externo		Pressão de Trabalho		Pressão de Ruptura		Raio de Curvatura
Polegada	Traço	Min	Max	Min	Max	Mpa	Psi	Mpa	Psi	mm
3/4"	12	18.6	19.8	31.0	33.2	35	5075	140	20300	240
1"	16	25.0	26.4	37.6	39.8	35	5075	140	20300	300
1 1/4"	20	31.4	33.0	48.3	51.3	35	5075	140	20300	420
1 1/2"	24	37.7	39.3	55.8	58.8	35	5075	140	20300	500
2"	32	50.4	52.0	69.5	72.7	35	5075	140	20300	640

Características Gerais

Construção: Tubo interno de borracha sintética com quatro camadas múltiplas de fio de aço trançado em espirais e direções alternadas, coberta com borracha sintética resistente a intempérie

Temperatura de Trabalho: -40 °C | +100 °C

Aplicação: Equipamentos Hidráulicos, com picos de pressões alta e condições extremas de operações, fluidos comuns minerais e sintéticos.

100R15

SAE 100R15



Tamanho		Diametro Externo	Diametro Interno	Working Pressure		Burst Pressure		Raio de Curvatura
Polegada	Traço	mm	mm	Mpa	psi	Mpa	psi	mm
3/4"	12	28.4	32.1	34.5	5000	138.0	20000	240
1"	16	35.2	38.7	34.5	5000	138.0	20000	300
1 1/4"	20	41.9	50.2	34.5	5000	138.0	20000	420
1 1/2"	24	48.8	57.7	34.5	5000	138.0	20000	500
2"	32	63.2	71.5	34.5	5000	138.0	20000	630

Características Gerais

Construção: Tubo interno de borracha sintética com uma ou duas camadas de fio de aço trançados coberta com borracha sintética resistente a intempérie, podendo ser lisa ou enfaixada.

Temperatura de Trabalho: -40 °C | +120 °C

Aplicação: Equipamentos Hidráulicos, com picos de pressões alta e condições extremas de operações, fluidos comuns minerais e sintéticos.

100R17

SAE 100R17



Tamaho		Diâmetro Interno		Diâmetro Externo		Pressão de Trabalho		Pressão de Ruptura		Raio de Curvatura
Polegada	Traço	Min	Max	Max	Mpa	Psi	Mpa	Msi	mm	
1/4"	04	6.2	7.0	13.2	21	3045	84	12180	80	
5/16"	05	7.7	8.5	15.0	21	3045	84	12180	55	
3/8"	06	9.3	10.1	17.0	21	3045	84	12180	65	
1/2"	08	12.3	13.5	21.1	21	3045	84	12180	90	
5/8"	10	15.5	16.7	25.9	21	3045	84	12180	105	
3/4"	12	18.6	19.8	30.3	21	3045	84	12180	125	
1"	16	25.0	26.4	38.6	21	3045	84	12180	150	

4SP

DIN EN 856 4SP



Características Gerais

Construção: Tubo interno de borracha sintética com quatro camadas de fio de aço trançado em espiral e direções alternadas, coberta com borracha sintética resistente a intempérie

Temperatura de Trabalho: -40 °C | +100 °C

Aplicação: Equipamentos Hidráulicos, com picos de pressões alta e condições extremas de operações, fluidos comuns minerais e sintéticos.

Tamanho		Diâmetro Interno		Diâmetro Externo		Pressão de Trabalho		Pressão de Ruptura		Raio de Curvatura
Polegada	Traço	Min	Max	Min	Max	Mpa	Psi	Mpa	Psi	mm
3/8"	06	9.3	10.1	20.6	22.2	44.5	6450	178	25810	180
1/2"	08	12.3	13.5	23.8	25.4	41.5	6020	166	24070	230
5/8"	10	15.5	16.7	27.4	29.0	35	5075	140	20300	250
3/4"	12	18.6	19.8	31.4	33.0	35	5075	140	20300	300
1"	16	25.0	26.4	38.5	40.9	28	4060	112	16240	340
1 1/4"	20	31.4	33.0	49.2	52.4	21	3045	84	12180	460
1 1/2"	24	37.7	39.3	55.6	58.8	18.5	2680	74	10730	560
2"	32	50.4	52.0	68.2	71.4	16.5	2390	66	9570	660

4SH

DIN EN 856 4SH



Características Gerais

Construção: Tubo interno de borracha sintética com quatro camadas de fio de aço trançado em direções alternadas, coberta com borracha sintética resistente a intempérie

Temperatura de Trabalho: -40 °C | +100 °C

Aplicação: Equipamentos Hidráulicos, com picos de pressões alta e condições extremas de operações, fluidos comuns minerais e sintéticos.

Tamanho		Diâmetro Interno		Diâmetro Externo		Pressão de Trabalho		Pressão de Ruptura		Raio de Curvatura
Polegada	Traço	Min	Max	Min	Max	Mpa	Psi	Mpa	Psi	mm
3/4"	12	18.6	19.8	31.4	33.0	42	6090	168	24360	280
1"	16	25.0	26.4	37.5	39.9	38	5510	152	22040	340
1 1/4"	20	31.4	33.0	43.9	47.1	32.5	4710	130	18850	460
1 1/2"	24	37.7	39.3	51.9	55.1	29	4205	116	16820	560
2"	32	50.4	52.0	66.5	69.7	25	3625	100	14500	700

Características Gerais

Construção: Tubo interno de PTFE com cobertura de Fio de Inox 304 resistentes a temperaturas, corrosão e anti aderente

Temperatura de Trabalho: -50 °C | +210 °C

Aplicação: Equipamentos Hidráulicos, pneumáticos e vapores diversos com picos de pressões alta e condições extremas de operações, fluidos comuns minerais, sintéticos e diversos.

100R14

SAE 100R14



Tamanho		Diâmetro Interno	Diâmetro Externo	Pressão de Trabalho	Pressão de Ruptura	Raio de Curvatura
Polegada	Traço	Max	Max	Bar	Bar	mm
1/8"	02	3,20	6,20	256	625	40
3/16"	03	4,80	7,70	240	570	55
1/4"	04	6,35	8,80	232	552	75
5/16"	05	7,90	10,80	194	540	100
3/8"	06	9,50	12,40	162	450	110
1/2"	08	12,70	15,90	139	425	140
5/8"	10	15,90	19,30	101	385	165
3/4"	12	19,05	22,30	92	315	200
7/8"	14	22,2	25,80	80	240	240
1"	16	25,40	29,80	72	200	300

Características Gerais

Construção: Tubo interno de EPDM/SBR reforço trançado de poliéster com cobertura de EPDM/SBR podendo ser enfaixada ou lisa.

Temperatura de Trabalho: -40 °C | +120 °C

Aplicação: Equipamentos Hidráulicos diversos com picos de pressões alta e condições extremas de operações, fluidos comuns minerais e sintéticos.

Multi Purpose

Mangueira Multi Uso

100% Borracha



Tamanho		Diâmetro Interno	Pressão de Trabalho	Pressão de Ruptura	Raio de Curvatura
Polegada	Traço				
1/4"	04	6,3	20	60	50
5/16"	05	7,9	20	60	80
3/8"	06	9,5	20	60	120
1/2"	08	12,7	20	60	140
5/8"	10	15,8	20	60	180
3/4"	12	19,05	20	60	240
7/8"	14	22,2	20	60	280
1"	16	25,7	20	60	350
1 1/4"	20	31,75	20	60	420
1 1/2"	24	38,1	20	60	500
2"	32	50,8	20	60	620

Freio Hidráulico - J1401

Mangueira para Freio Hidráulico



Características Gerais

Construção: Tubo interno de borracha sintética com duplo reforço de fio textil de alta tenacidade e resistencia, cobertura também em borracha sintética resistente a óleo, intempérie e abrasão.

Temperatura de Trabalho: -40 °C | +100 °C

Aplicação: Sistemas de freio hidráulicos automotivos.

Tamanho		Diâmetro Interno		Diâmetro Externo		Pressão de Trabalho		Pressão de Ruptura		Raio de Curvatura
Polegada	Traço	Min	Max	Min	Max	bar	Psi	Mpa	Psi	mm
1/8"	02	3,1	3,3	10	10,5	200	2900	600	8700	100

Direção Hidráulica - J2050

Mangueira para Direção Hidráulica



Características Gerais

Construção: Tubo interno de borracha nitrílica (NBR) com duplo reforço de fio de poliéster de alta tenacidade e resistência, cobertura em borracha sintética resistente a óleo, intempérie e abrasão.

Temperatura de Trabalho: -40 °C | +100 °C

Aplicação: Sistemas de Direção Hidráulica Automotiva (Atende os requisitos da norma SAE J2050)

Tamanho		Diâmetro Interno		Diâmetro Externo		Pressão de Trabalho		Pressão de Ruptura		Raio de Curvatura
Polegada	Traço	Min	Max	Min	Max	bar	Psi	Mpa	Psi	mm
3/8"	06	9,4	9,6	18,9	19,01	86	1250	344	5000	102